



**Ergonomic Lifting Systems
for Repetitive Handling**

Vacuum Tube Lifting Systems

**Unmatched
Quality and Value**

Made in USA since 1968



Featuring **Armadillo™**
Long-Wearing Vacuum Tubes



Index

ANVER® VT Systems	2-3
Unique Features	4-6
Micro VT Systems	7
Mini VT Systems	8-9
Standard VT Systems	10-11
Various Applications	12-13
Large Capacity VT Systems	14-15
Armadillo Lift Tubes	16
Compressed Air Attachment	17
Selecting a VT System	18-19

Accessories:

Vacuum Stations	20-21
Vacuum Lift Pads	22-23
Filters, Hose, Fittings	24-25
System Controls	26
Extending Your Reach	27

Other Systems:

VM Vacuum Lift Systems	28-31
VB Vacuum Lift Systems	32-33
Custom Lifting Systems	34-35

ANVER® is the registered trademark of ANVER Corp.

© Copyright ANVER Corp. 2005

Printed in USA

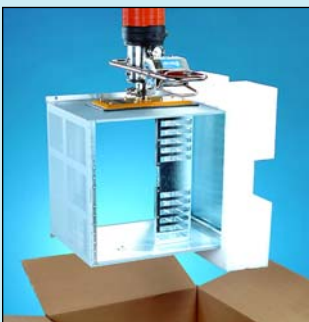

We help keep things moving



An ANVER® VT Vacuum Tube Lifting System can help increase your productivity while offering an ergonomic solution to your material handling needs.

■ Easy to Operate

ANVER VT Tube Lifting Systems require minimal operator training. ANVER VT systems grab the load (by vacuum suction), support, lift and lower the load, all with a single operator control. The use of vacuum pads for

attachment allows objects to be lifted without the damage to the surface or edges of the product often caused by manual lifts or grabs.

■ Quality Design

All ANVER VT lifting systems feature stainless steel construction throughout. A wide assortment of vacuum pad attachments make an ANVER VT System ideal for many material handling needs.

■ Ergonomic Handling

ANVER VT Vacuum Tube Lift Systems are ideal for repetitive handling of either non-porous, semi-porous or porous loads. Models are offered to handle loads from 5 lb (2.3 kg) for non-porous loads, all the way up to 660 lb (300 kg). Actual system capabilities vary based upon the tube size, pad attachment and vacuum station used.

...by giving you a lift assist



virtually any item to which a vacuum pad can be attached. Palletizing, stacking, the loading and unloading of bags, sacks, and cartons, and the lifting of printed material, buckets, drums, pails and woven goods are among typical uses. Raw materials can be lifted and lowered into position for weighing, emptying or mixing ingredients in the food, pharmaceutical or chemical industries.

ANVER VT lifting systems have also found their place in the manufacturing assembly process for the lifting and placing of items into position, such as lifting a TV picture tube into its chassis.

■ Easy to Use & Install

An ANVER VT Vacuum Tube Lifter uses vacuum to both attach to and lift a load, eliminating the need for chain hoists or manipulators. When the system's vacuum pads touch the load, the air flow is blocked, causing the vacuum level to increase until the load is lifted. A hand valve allows just enough leakage of air to control speed and height. When the load is set down, the valve is opened fully to release the load.

■ Experience Counts

Since 1968, ANVER has been manufacturing an extensive line of vacuum lifting systems, including vacuum tube lifters, coil lifters, sheet and plate lifters, tilters and rotators. Our applications engineers can provide a thorough technical review of your system requirements and help you select the right vacuum lifter for your needs and budget from our extensive range of standard as well as specialized systems.



ANVER vacuum tube lifting systems are rapidly becoming the system of choice for applications in which single operator material handling of repetitive or heavy loads is required. These systems are used by many of the largest US manufacturers, yet their affordable pricing has made them a practical tool for the smallest companies.

Vacuum tube lifters are used for packing TVs, small appliances, computer equipment, furniture,

ANVER Vacuum Tube Lifting Systems

Item for item, ANVER is dedicated to offering the highest quality vacuum tube lifting systems, which is the basis of our continuing success. We invite direct comparison to any competitive system.



► The following items are standard for every ANVER VT System:

- Vacuum Station with Muffler
- Lifting Tube with Top Swivel and Control Head
- Filter with Vacuum Gauge
- Vacuum Hose
- Free Pad Attachment
- Instruction Manual

► ANVER VT Tube Lift Systems can be mounted to any overhead, wall or pedestal mount jib or workstation crane.

Features found in every ANVER VT Vacuum Tube Lifting System:

■ Easy Maneuverability

Winning universal acceptance among operators, ANVER VT Tube Lift systems have little bulk yet feel secure. The lifting tube bears all the load weight, allowing the operator to effortlessly maneuver and position the load.

■ Corrosion Resistance

External surfaces combine stainless steel, anodized aluminum, epoxy-coated metal, and nylon components, all FDA approved for washdown and food service applications.

■ Simple Operation

An ANVER VT system is simple to operate and easily adjusts to any working height. Training is minimal; most operators become productive within minutes.

Once properly mounted, the VT system becomes an ergonomic tool that increases productivity while reducing labor content in the work place.

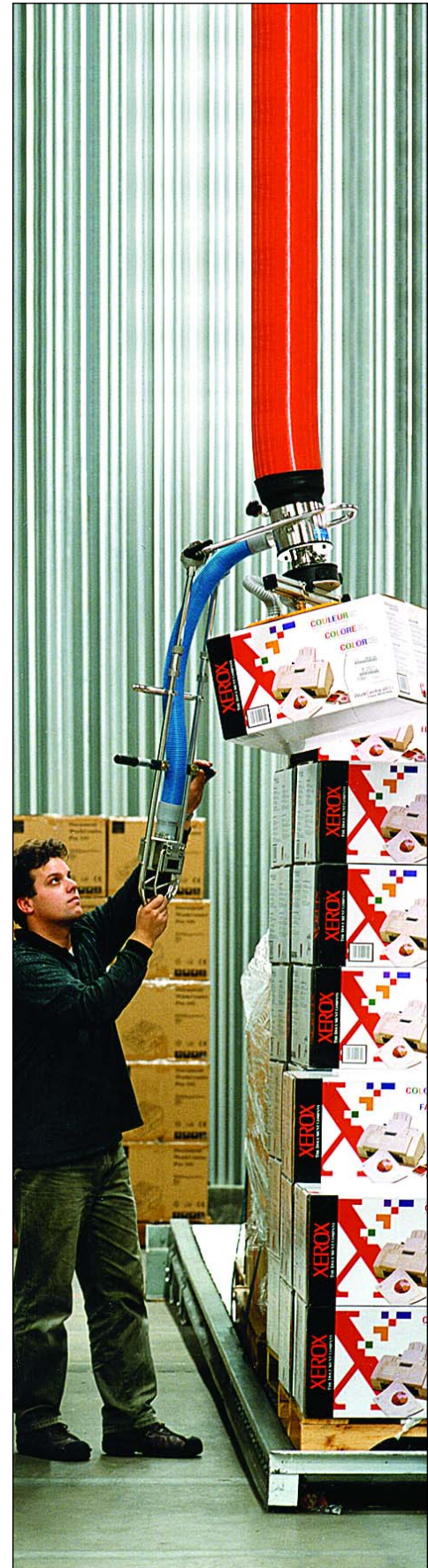

...with features that set us apart

■ Vacuum Gauge on the Control Head

Only ANVER VT Tube Lift Systems are equipped with a vacuum gauge on the control head to readily indicate to the operator that the load is securely attached and ready for lifting.

■ Simple 'Hand Squeeze Against Spring Resistance' (Adjustable) Control

The ergonomically designed control handle has made the unit a favorite among operators. The control is activated by simply squeezing the lever with the thumb and fingers in a natural grasping motion.

■ Double Layer Reinforced Lift Tubes

ANVER Vacuum Lift Tubes feature a heavy-duty steel wire reinforced construction which is then wrapped, reducing the chance of vacuum leakage.

■ Improved Conical Flow Control Valve

The redesigned conical flow valve allows the operator to precisely control the vacuum power, resulting in a much smoother, more ergonomic and user-friendly control than competitive units.

■ Power Loss Check-Valve

In the event of an electrical power failure or pump malfunction, a check valve helps to maintain vacuum in the lift tube, allowing elevated loads to slowly and gently descend back to the floor.

■ Multi-function Lift Control

Micro-adjustment of tube lift and acceleration are accomplished with the same control on the front handle that regulates air suction power. Stainless steel adjustment knobs and nylon valve seats on the control head ensure accurate and consistent settings every time.



■ PVC Cuffs and Stainless Clamps

In addition to the use of quality kink-free supply hoses, ANVER systems include PVC hose cuffs and stainless steel clamps throughout, for solid, vacuum-tight connections.

■ Quick Disconnects

Quick Disconnects for pad attachments adjust a full 360° and can be locked into position, an ANVER Exclusive Feature.

■ Standard Vacuum Pad Attachment Included with Each Complete System

Every ANVER VT Tube Lift System price includes a standard vacuum pad attachment chosen by our applications engineers to suit the job at hand. (No need to consider pad attachment as additional add-on cost item.)

■ Fully Adjustable Vacuum Pad Attachments

All ANVER Vacuum Pad Attachments offer heavy-duty construction and corrosion resistance. Multiple pad attachments offer independently adjustable pad slides mounted on an aluminum channel with knurled locking knobs. Pads feature spring action clevis mounts to allow handling of open flaps as well as sealed cartons.



Top quality for reliability

- ▶ Standard Vacuum Pad Attachment included with each VT system
- ▶ Replacement Pad Attachments and Seals Available in Many Styles to Handle Almost Any Load



- ▶ In-line Filter Protects the Vacuum Pump
- ▶ Vacuum Gauges on the Filter and Lifter Head for Monitoring System Performance
- ▶ Direct-Drive Vacuum Pumps are Standard with ANVER VT Systems for Maintenance-Free Operation
- ▶ VT Systems Feature High Quality Components and Superior Engineering and yet are Economically Priced

- **In-line Filters Protect the Vacuum Pumps**
ANVER VT Tube Lift systems include in-line air filters to protect the vacuum pump from debris. A vacuum gauge mounted on the filter aids in monitoring the system vacuum level.



- **Fast, Smooth Operation**
ANVER VT Vacuum Tube Lift systems have a high duty cycle and can operate continuously with unlimited stops and starts, making the systems ideal for high-speed production line applications.
- **Direct-Drive Vacuum Pumps**
ANVER VT Tube Lift Systems feature special high efficiency model vacuum pumps built exclusively for ANVER. These precision die-cast, direct drive pumps have made other pumps obsolete for vacuum tube lifting applications.

- **More Lift Capacity per Pad Size**
ANVER's use of direct-drive pumps produces 18" Hg vacuum vs. the 12"-16" Hg produced by competitive units with belt-drive pumps.

As a result, an ANVER VT System with a 140 mm diameter tube is able to lift the same loads as competitive units equipped with a 160 mm diameter tube.

- **Low Maintenance**
Superior engineering and meticulous workmanship make ANVER VT Tube Lift systems highly reliable with minimal downtime. Maintenance-free pumps eliminate complicated and time-consuming servicing requirements.

- **Full Range of Options and Accessories**

ANVER offers a wide range of optional accessories to adapt our systems to virtually any lifting requirement, including extended length control handles, tube head pad extensions, drum filters, special length vacuum tubes and supply hoses, and sound deadening pump enclosures. Contact ANVER for an economical solution to your lifting problems.



Micro VT Systems



The Micro Tube Lifter VT90, the newest addition to our line of vacuum tube lifting systems, features a lifting tube with a diameter of only 90 mm (3.54"), a sub-compact size control head, and smaller vacuum attachment pads.

■ Lifts Small, Light Loads

With a smaller diameter lifting tube and lifting pads smaller in area than those used on our Standard or Mini Tube Lift Systems, the Micro system is especially suited for lifting small, light loads.

■ Ergonomic Operation

The Micro VT90's sub-compact design allows for quick, easy, ergonomic operation in close proximity to the operator. The handles permit one or two hand operation.

■ Production Lifting and Packaging

The Micro Tube System's continuous duty cycle makes it well suited for lifting and packing small, compact items on a fast paced production basis.

■ Lifts up to 65 lb (29 kg)

Non-porous loads weighing as much as 65 pounds (29 kg) can be easily handled with the Micro VT90 system.

■ Easy Festooning

The Micro VT90 System's use of a small diameter supply hose makes festooning lighter and less cumbersome.

■ Smooth Operation

The control head handle is easy to grasp with operator controls designed for smooth, effortless operation.

■ High Quality

As with all ANVER Tube Lift Systems, Micro VT90 Vacuum tube lift systems are manufactured using only the highest quality processes.

■ Low Price

ANVER Micro VT90 Tube Systems are economically priced and are the most affordable choice for applications where repetitive handling of lightweight, compact loads is required.

Contact ANVER for help in choosing the appropriate tube lift system for your requirements.

Load Lifting Capacity Range

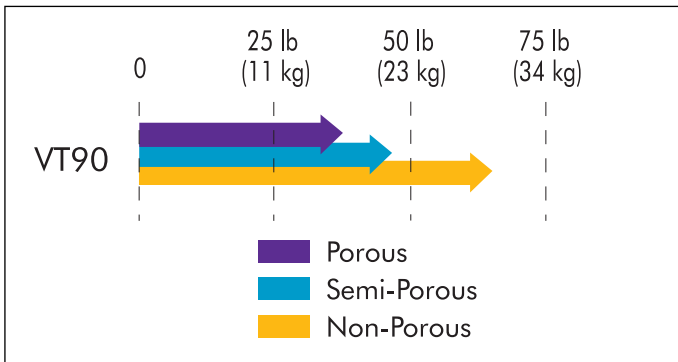

Capacities with Specific Stations

Vacuum Station Model	System Model Number		
	VT90		
	Non-Porous lb (kg)	Semi-Porous lb (kg)	Porous lb (kg)
VB3HF-S	25 (11)	18 (8)	12 (5)
VB4HF-S	45 (20)	37 (17)	30 (14)
VB7HV-S	65 (29)	48 (22)	32 (15)



Important Note:

These capacity ranges should only be used as general guidelines. Actual system capacities depend on several factors (load surface porosity, load density, vacuum station, pad attachment, etc.)

Mini VT Systems



Mini VT models of ANVER Vacuum Tube Lift Systems are available with lifting tube diameters of 100 mm (3.9") for the Model VT100, 120 mm (4.7") for the Model VT120 and 140 mm (5.5") for the Model VT140.

Mini VT Systems, with their smaller lift tubes and control heads, are favored by many operators for their ability to handle the most common load sizes effortlessly. The Mini VT's continuous duty cycle makes it an ideal production lifting system.

Smaller Control Head Design

ANVER's Mini Tube Lift Systems feature a control head design similar to that on our standard series of tube lifters but smaller in size, making the Mini VTs lighter and more compact.

Easy to Position

The control head is easy to position and its near-effortless movement allows for fingertip control by even the most petite operators.

Simple to Operate

The handlebar is easy to grasp, with operator controls ergonomically designed for smooth operation. A conical flow valve allows the operator to precisely control the vacuum power, resulting in a much smoother, more user-friendly control than found in outdated competitive designs.

Lighter Festooning

The Mini Systems use a 1.5 inch diameter supply hose instead of the 2 inch hose used on our standard systems, which makes festooning lighter and less cumbersome.

Higher Efficiency

A VT140 Mini Tube Lift System supplied with our standard high efficiency direct-drive vacuum pump can offer the same lifting capacity as a competitive unit equipped with a 160 mm or larger lifting tube but supplied with a less efficient belt-drive vacuum pump.

High Quality

Mini VT Systems are manufactured using the highest quality processes and componentry. The control head, handle, and control knobs are manufactured out of electro-polished heavy gauge stainless steel for corrosion resistance.



Compact and easy to operate

Low Price

ANVER Mini VT Systems are economically priced, and affordable for many of the more common load lifting and stacking requirements.

ANVER VT Mini Tube Lifting Systems can be configured to handle all load types: porous, semi-porous and non-porous. For porous and semi-porous load handling, we recommend that you allow us the opportunity to test your load in order to determine the actual system capacity and capability.

ANVER offers a free testing service in our ergonomics lab to assist you in determining your load's porosity and to help you in choosing the appropriate vacuum lifting system.



Load Lifting Capacity Range

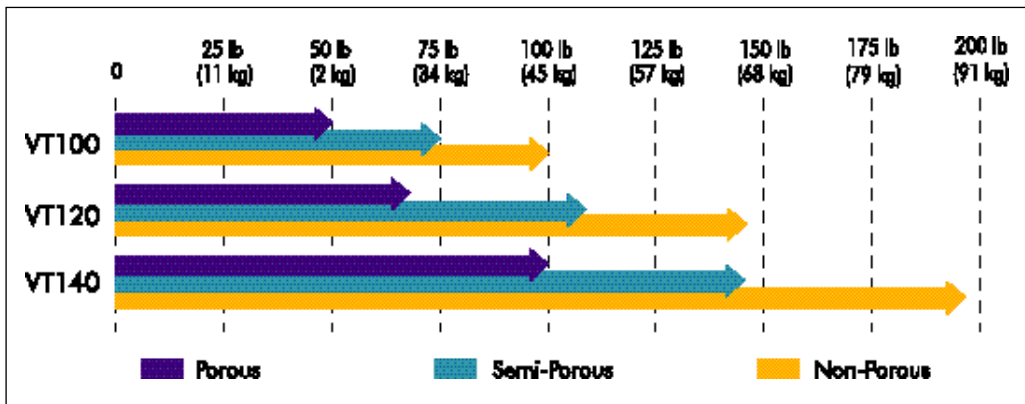

Important Note:

These capacity ranges should only be used as general guidelines. Actual system capacities are dependent on several factors (load surface porosity, load density, vacuum station, pad attachment, etc.)

We offer many combinations of VT Tube Lifting systems within each model range. Contact your local ANVER dealer for a free evaluation and recommendation of a system combination that will most economically and safely satisfy your material handling requirements.

Load Lifting Capacities with Specific Vacuum Stations

Vacuum Station Model	System Model Numbers								
	VT100			VT120			VT140		
	Non-Porous	Semi-Porous	Porous	Non-Porous	Semi-Porous	Porous	Non-Porous	Semi-Porous	Porous
	lb (kg)	lb (kg)	lb (kg)	lb (kg)	lb (kg)	lb (kg)	lb (kg)	lb (kg)	lb (kg)
VB3HF-S	30 (14)	23 (10)	15 (7)	50 (23)	38 (17)	25 (11)	75 (34)	56 (25)	38 (17)
VB4HF-S	55 (25)	47 (21)	40 (18)	80 (36)	70 (32)	60 (27)	110 (50)	95 (43)	85 (39)
VB6-S	100 (45)	75 (34)	50 (23)	145 (66)	110 (50)	70 (32)	195 (88)	145 (66)	100 (45)
VB7HV-S	85 (39)	65 (29)	45 (20)	125 (57)	95 (43)	60 (27)	160 (73)	125 (57)	80 (36)
VB9HV-S	95 (43)	70 (32)	50 (23)	140 (63)	105 (48)	70 (32)	185 (84)	140 (63)	95 (43)

Important Note:

The above capacity ranges should only be used as general guidelines. Actual system capacities are dependent on several factors (load surface porosity, load density, vacuum station, pad attachment, etc.)

Standard VT Systems



ANVER's Standard Vacuum Tube Lift Systems have a wide range of applications and have traditionally been the most popular choice of users. They are available in tube diameters of 160 mm (6.3") for the Model VT160, 180 mm (7.1") for the Model VT180 and 200 mm (7.9") for the Model VT200.

Redesigned for Improved Operation

The latest models of these popular systems have been redesigned for improved operation and load lifting capability using only the highest quality manufacturing processes and state-of-the-art componentry.

Corrosion Resistant

The control head, handle, and control knobs are manufactured out of electro-polished heavy gauge stainless steel for corrosion resistance.

Precise Control

The redesigned conical flow valve allows the operator to precisely control the vacuum power, resulting in a much smoother, more ergonomic and user-friendly control than that provided with competitive units.

Smooth Operation

ANVER Standard VT Lifter features include an extended length handlebar that is easier to grasp, and fully protected operator controls that result in smoother operation.

Low Price

These continuous design and quality improvements have actually allowed us to decrease prices for the most popular of these models, making them affordable for a wide range of lifting applications.

► Our Standard Model VT160-2.5 with a 2.5 meter length lift tube has been a consistent top seller. Available with a variety of pumps, it is known as a workhorse and an industry favorite.



Load Lifting Capacity Range



Important Note:

The above capacity ranges should only be used as general guidelines. Actual system capacities are dependent on several factors (load surface porosity, load density, vacuum station, pad attachment, etc.)

We offer many combinations of VT Tube Lifting systems within each model range. Contact ANVER or your local ANVER dealer for a free evaluation and recommendation of a system combination that will most economically and safely satisfy your material handling requirements.



...for the widest range of applications

ANVER VT Tube Lift Systems are designed for heavy production use. With their continuous duty cycle, unlimited starts and stops per minute are possible, and vacuum attachment to and release of the load is instantaneous.



■ Easy to Operate

All ANVER VT Vacuum Tube Lift Systems use the same basic operating principle: a remotely connected vacuum pump produces a vacuum in the lifting tube and control head. As the control head and pad attachments are placed on the object to be lifted, the pads seal onto the object and the vacuum in the lift tube increases, causing the lift tube to contract, raising the load. As the vacuum (continuously controlled and regulated by the operator using the control handle) is decreased, the lift tube expands, lowering the load. Providing a simple, reliable means for a single operator to effortlessly handle virtually any load.

■ Rugged Construction

ANVER Standard VT pad attachments are mounted to the system control head with a total of six bolts for improved rigidity and added security.

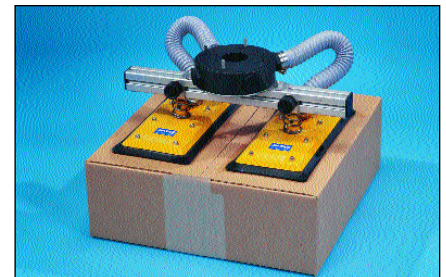

Load Lifting Capacities with Specific Vacuum Stations

Vacuum Station Model	System Model Numbers								
	VT160			VT180			VT200		
	Non-Porous lb (kg)	Semi-Porous lb (kg)	Porous lb (kg)	Non-Porous lb (kg)	Semi-Porous lb (kg)	Porous lb (kg)	Non-Porous lb (kg)	Semi-Porous lb (kg)	Porous lb (kg)
VB4HF-S	140 (63)	120 (54)	100 (45)	180 (82)	150 (68)	125 (57)	220 (100)	190 (86)	160 (73)
VB6-S	240 (109)	180 (82)	120 (54)	305 (138)	230 (104)	155 (70)	375 (170)	280 (127)	190 (86)
VB7HV-S	180 (82)	135 (61)	90 (41)	210 (95)	160 (73)	105 (48)	260 (118)	195 (88)	130 (59)
VB8HF-S	150 (68)	140 (63)	125 (57)	190 (86)	175 (80)	160 (73)	240 (109)	215 (98)	195 (88)
VB9HV-S	225 (102)	170 (77)	115 (52)	285 (129)	215 (98)	145 (66)	355 (161)	265 (120)	175 (79)

Important Note:

The above capacity ranges should only be used as general guidelines. Actual system capacities are dependent on several factors (load surface porosity, load density, vacuum station, pad attachment, etc.)

VT Systems

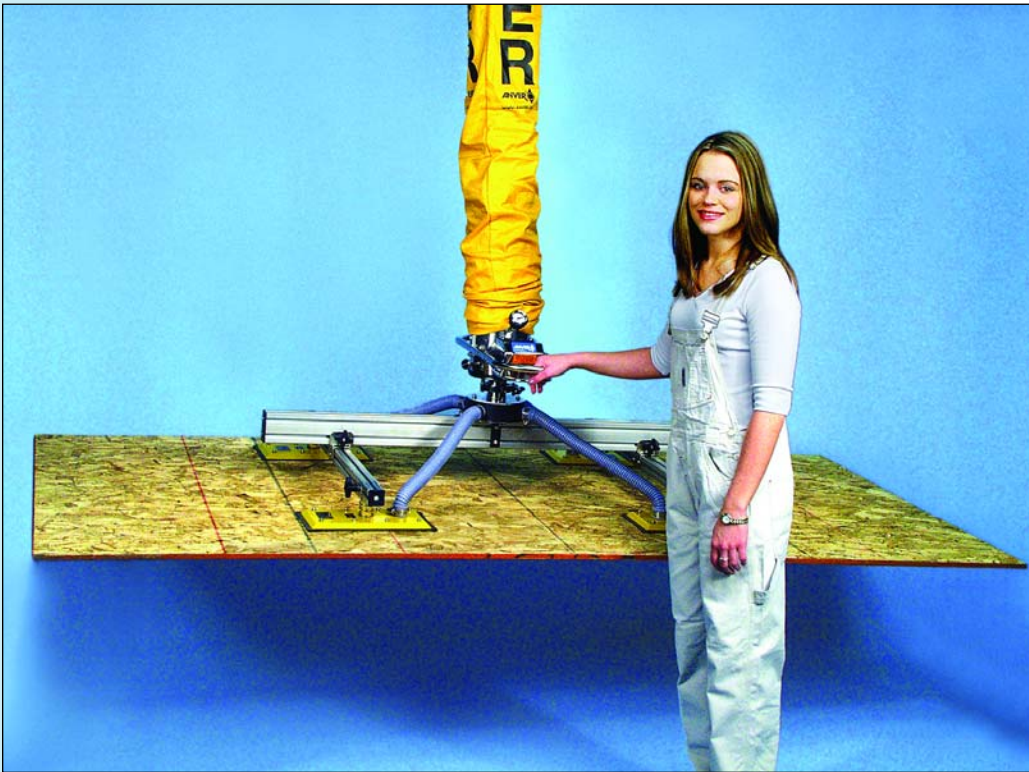

■ The ANVER VT200

Vacuum Tube Lifter features a handle with up/down controls that can be adjusted to match a user's hand strength and provides large pads securely mounted to the system control head. Allowing one person to pick up plywood panels and load tables or furniture into a box, this same lifter can also be used to handle the packed box.

■ Coil Handling

Anver Coil Handling lifters feature adjustable pad attachments for handling various types of coils without using mechanical devices which can damage the core. With an easy to grip handle and up/down controls that can be adjusted to match an operator's hand strength, this lifter provides a 100% duty cycle and swivels 360° under vacuum.



► We will test the load in our lab and build a custom vacuum pad attachment as needed.



...for various applications



■ Vacuum tube lifters are being used for packing small appliances, electronic equipment, furniture; virtually any item to which a vacuum suction pad can be attached. Palletizing, stacking, the loading and unloading of bags, sacks, and cartons, and the lifting of printed material, buckets, drums, pails and woven goods are typical uses. Raw materials can

be lifted and lowered into position for the weighing, emptying or mixing of ingredients in the food, pharmaceutical or chemical industries. ANVER VT Vacuum Tube Lifting Systems have also found their place in the manufacturing assembly process for the lifting and placing of items into position, such as lifting a TV picture tube into its chassis.

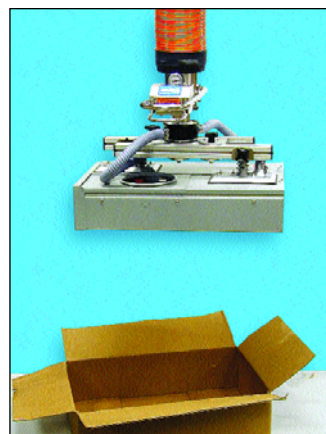
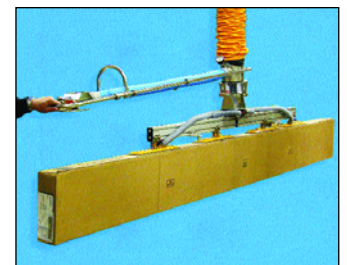
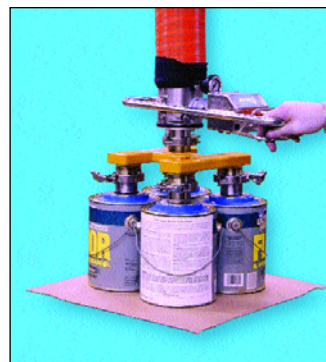

■ Since 1968, ANVER has been manufacturing an extensive line of vacuum lifting systems, including vacuum tube coil lifters, wood panel lifters, tilters and rotators.

Our applications engineers can provide a thorough technical review of your system requirements and help you to select the right vacuum lifter for your needs and budget from our extensive range of standard and specialized vacuum lifting systems.

Large Capacity VT Systems



ANVER's Large Capacity VT Vacuum Tube Lift Systems feature high capacity lifting tubes in either a single 250 mm or double tube 200 mm size. These Large Capacity VT systems are designed for handling heavier loads while continuing to provide all the advantages of a single control system.

- ▶ Up to 660 lb (300 kg) loads can be handled with the ease only a Vacuum Tube System can offer!
- ▶ Available in two sizes: 200 mm double tube and 250 mm single tube
- ▶ Front-mounted Vacuum Gauge for Monitoring System Performance

■ A Single Operator Control

The Large Capacity lifting tubes are attached to a single operator control and vacuum pad attachment. Individual tube sizes are 200 mm (7.9") for the VT2200 double tube system, and 250 mm (9.8") for the VT250 single tube system.

■ Heavyweight Load Handling

When supplied with an ANVER high air flow vacuum station, a Large Capacity system can handle loads of up to 660 lb (300 kg).

■ Durable Lift Tubes

The lift tubes are constructed out of heavy-duty steel wire reinforced tubing, double wrapped for extended operating life.



Load Lifting Capacity Range

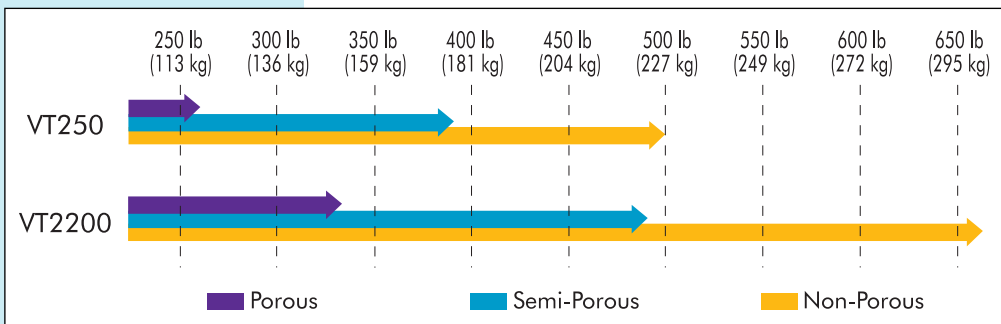

Important Note:

These capacity ranges should only be used as general guidelines. Actual system capacities are dependent on several factors (load surface porosity, load density, vacuum station, pad attachment, etc.)

Load Lifting Capacities with Specific Stations

Vacuum Station Model	System Model Numbers					
	VT250			VT2200		
	Non-Porous lb (kg)	Semi-Porous lb (kg)	Porous lb (kg)	Non-Porous lb (kg)	Semi-Porous lb (kg)	Porous lb (kg)
VB6-S	500 (227)	375 (170)	250 (113)	660 (300)	485 (220)	325 (147)
VB8HF-S	400 (181)	330 (150)	260 (118)	500 (227)	415 (188)	330 (150)
VB9HV-S	470 (213)	350 (159)	235 (107)	610 (277)	455 (206)	305 (138)



...with the advantages of a single control system

■ Easy to Operate

An easy to grasp extended length handlebar is provided for improved operator control and smooth operation. A conical flow valve allows the operator to precisely control the vacuum power, resulting in a much smoother, more ergonomic and user-friendly control than that provided with outdated competitive designs.

■ Affordably Priced

ANVER Large Capacity VT Vacuum Lift systems are affordably priced and their continuous duty cycle makes them the system of choice for heavyweight load lifting requirements.



Other Vacuum Lifters are Available for Heavier Loads

■ ANVER manufactures a wide range of standard and custom vacuum lifters: Mechanical, electrical or air-powered, offering material handling solutions for all applications. Our application engineers will help you select the right vacuum system and componentry for your needs.



■ ANVER vacuum lifters, rotators, tilters and a huge array of specialized pads and attachments make it possible to handle almost any load!



■ Any Object

Sheet and plate, coil, pipe, ingots, boxes, bags, sacks, paper, appliances, cabinets, etc.

■ Any Material

Metal, concrete, foam, wood, stone, plastic; in short, any porous or non-porous, smooth or rough material.

■ Any Shape

Concave, convex, flat, ribbed, uneven, wavy surfaces, etc.

■ Any Action

Lifting, picking, tilting, rotating, placing, packing, etc.

■ Any Environment

Indoors, outdoors, dusty, hot, mill-duly, production line use, etc.

■ Lift, Tilt or Manipulate Heavy Loads with Ease.



Armadillo Lift Tubes



Lift Tube Covers

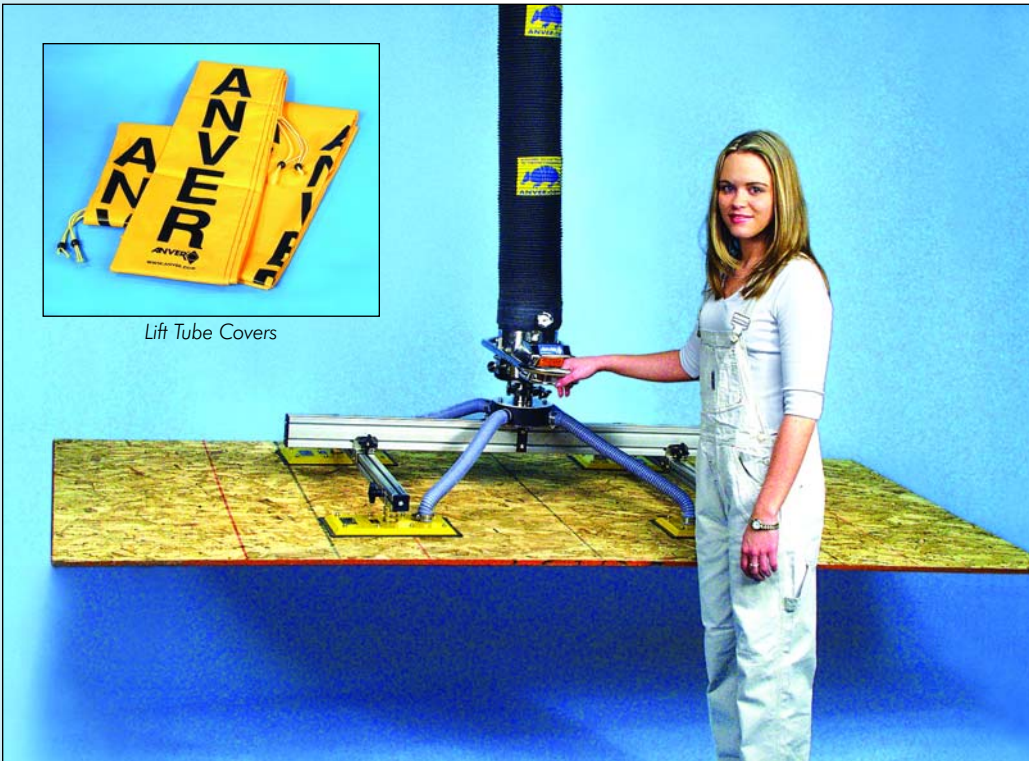

■ ANVER vacuum lifting tubes not only make your vacuum tube lifting system safer by reducing the danger of vacuum leakage, they also make maintenance less expensive. As the leading North American manufacturer of Vacuum Tube Lifting Systems, ANVER can offer these high quality replacement vacuum lifting tubes at prices substantially lower than those of smaller competitors or expensive imported brands. The use of ANVER vacuum tube lifting clamps and rubber clamping bands along with our new lifting tube covers allow you to easily complete the installation of replacement lift tubes with a professional appearance.

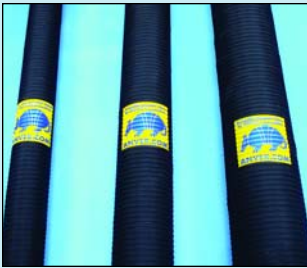

■ ANVER Armadillo™ Vacuum Lifting Tubes are manufactured with a Black outside wrap. We also make tubes with an orange or yellow outside wrapping. (ANVER has also supplied tubes over the years in a variety of other colors including white, black, grey and blue as well as different fabrics and coatings.)

■ ANVER Armadillo™ Vacuum Lift Tubes feature super-duty steel-wire reinforced construction. They are built with a reinforced black rubber wrap, making them longer lasting than standard plastic coated vacuum lifting tubes. These tubes are industrial grade and are long wearing in the toughest conditions.



CLP-160-D Tube Lifting Clamp



CLP-250-TB Tube Lifting Clamp



Rubber Clamping Band



Armadillo Vacuum Tubes
by ANVER Corporation



► Contact ANVER for the latest in vacuum tube technology and products.



Compressed Air offers power to the attachment

- ANVER VT Vacuum Tube Lifters can be equipped with an optional internal compressed air line to provide an auxiliary source of power to the tube lifter control head. When connected to a source of clean, dry compressed air, the internal air line outlet at the tube lifter control head can provide pneumatic power that can be used to assist in load handling by powering vacuum head attachments such as pneumatic rotators and tilters, or to actuate a valve to close off vacuum flow to the vacuum pads and assist in the releasing of loads in high stacking applications.
- The internally coiled air line is rotary coupled to the tube lifter top swivel to provide full, unimpeded 360 degree rotation of the lift tube. The air outlet port is conveniently located on the tube lifter control

head. The internal air line, with no exposed lines between the top swivel and control head outlet port, permits unimpeded operation of the vacuum tube lifter with no adverse effects on the tube lifter's operation or performance.

- The CA option is available for the Standard Series VT Tube Lifters: VT160, VT180, VT200 and VT250. Custom as well as standard vacuum lifting attachments are available from our extensive inventory of vacuum attachments designed for use with for boxes and cartons, bags and sacks, sheets, coils and rolls. Contact the factory or your ANVER dealer for further product information.
- Compressed air line is housed within the lift tube for unencumbered lifter operation.

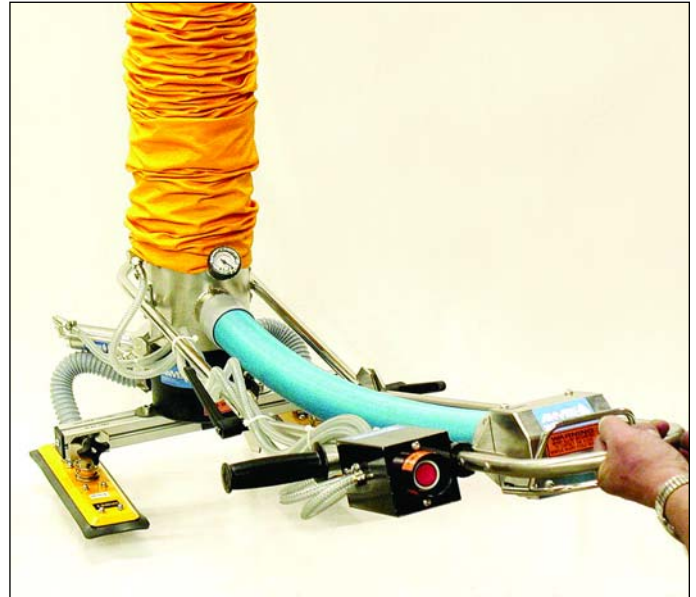

- A 1/4" female port for compressed air quick disconnect is featured.
- The 360° top swivel allows lift tube to fully rotate beneath the crane.
- For most applications, the CA Feature works with standard shop air-clean, dry, 72 psi.

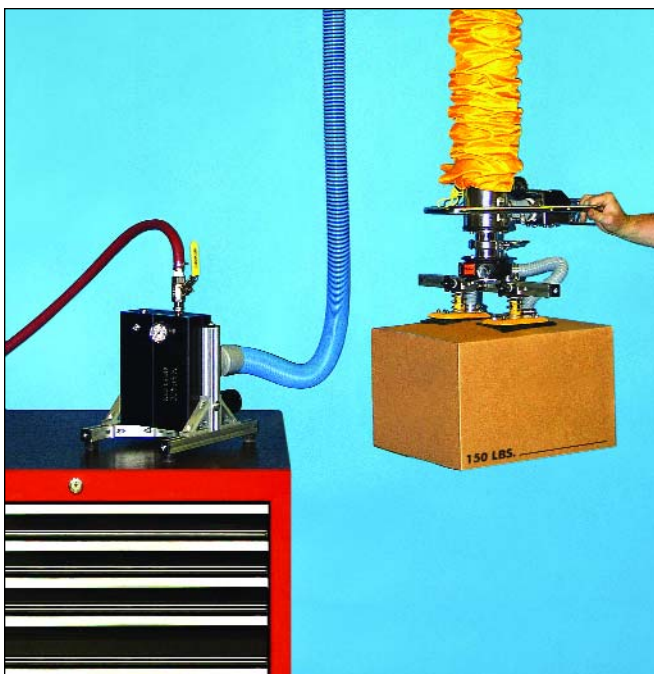
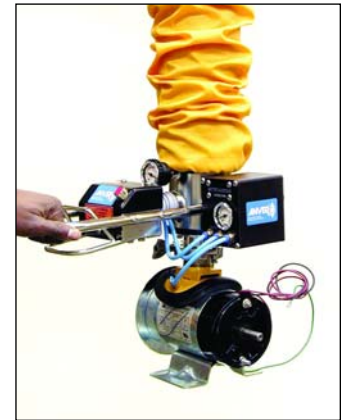

...and Air Powered Systems

- The ANVER VT-Series Tube Lifter and MSP400 Multi-Stage Air-Powered Vacuum Station operate on the venturi principle to provide vacuum levels as low as 27" Hg and flows to 148 SCFM. Ideal for handling boxes and bags in explosive environments, this ergonomic lifter eliminates electric pump burn-out, has no internal moving parts or bearings, and is virtually maintenance-free.
- Providing a 100% continuous duty cycle, the ANVER VT-Series Tube Lifter and MSP400 Multi-Stage Air-Powered Vacuum Station are designed for loads weighing up to 150 lbs. The vacuum lifter has an easy grip handle with up/down controls that adjust to a person's hand strength as well as a quick-connect pad attachment. The compact vacuum station measures only 10" W x 12.5" D x 7.5" H.

Selecting the Right VT Tube System

ANVER offers several sizes and styles of vacuum tube lifting systems. Selecting the system that will most efficiently meet your load lifting requirements will increase your productivity and provide a safer working environment.

System lifting capacities and capabilities are dependent on several factors, including:



- The weight and material composition of the load to be lifted (porous, non-porous or semi-porous)
- Total load surface available for lifting
- The style of load to be lifted (loose or densely packed, light or heavy wall, compact or bulky size)
- The system vacuum station (High or Low Vacuum and Flow)
- The resulting vacuum level achieved
- The vacuum pad attachment size and style
- The vacuum safety factor (tube diameter area in proportion to vacuum pad area).



Our applications engineers will help ensure that:

- *You select a system with a rated capacity that matches your needs.* While you can not use a system with a rated load capacity less than your load size, you also should not choose a system that is too powerful. A system that is too large may not operate smoothly.

the vacuum level generated is constant throughout the system. Attachment pads grip the load at the same vacuum level as the vacuum level in the lifting tube. The pad's rated gripping force must be considerably greater than the actual weight of the load to prevent the load from peeling off and dropping.

ANVER recommends a rated gripping force of at least twice the load's weight (2 to 1). Since both gripping and lifting operations are accomplished at the same vacuum level, a rated gripping force twice the weight of the load requires the use of properly rated pads with a seal surface area twice the lifting tube area.

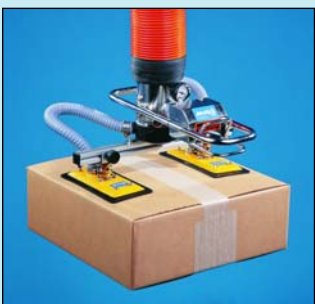

▶ A 2 to 1 Vacuum Pad to Tube Diameter Safety Factor is recommended

- *You choose the right vacuum station.* ANVER's HV pumps produce high vacuum and are ideal for heavy, non-porous loads. HF pumps produce high flow making them ideal for porous loads.
- *You choose the right vacuum attachment based on the type of load.* Using the right attachment will not only make your system more productive, but safer to operate.
- *You consider the lifting tube diameter.* In a vacuum tube lift system,



...for safety and performance

Recommended minimum surface area for ANVER VT Systems:

System No. (Dia. in)	Tube Area sq cm (sq in)	Minimum Pad Area sq cm (sq in)
VT90 (3.54)	65 (10)	130 (20)
VT100 (3.9)	77 (12)	155 (24)
VT120 (4.7)	110 (17)	220 (35)
VT140 (5.5)	155 (24)	310 (48)
VT160 (6.3)	194 (30)	387 (60)
VT180 (7.1)	258 (40)	516 (80)
VT200 (7.9)	316 (49)	632 (98)
VT250 (9.8)	490 (76)	980 (152)
VT2180 (2 X 7.1)	516 (80)	1032 (160)
VT2200 (2 X 7.9)	632 (98)	1264 (196)



- For some applications, tube lifting systems may not offer the proper lifting capability, so ANVER also offers combination hoist or balancer lifting systems.
- Sometimes a hoist-based lifter is a better choice for very heavy loads. This is especially true for non-porous loads. ANVER manufactures a complete selection of standard and custom vacuum lifters. Our application engineers will help you select the right vacuum system for your needs.

- ANVER is the #1 supplier of Vacuum Lifting Tubes and Vacuum Tube Lifting Systems in North America. Our sales volume equals top value for you.
- Replacements are available for all vacuum tube lifter brands, foreign and domestic, including spin-on adapter styles.
- All ANVER Vacuum Lifting Tubes are now available with Lift Tube Covers for Maximum Protection.
- Due to our high production volume, ANVER has the lowest prices in the industry.
- We can reduce your Lift Tube Replacement Costs by 50% or more.
- We maintain high stock quantities for quick shipping.



Powerful yet Quiet: High Efficiency Pumps



ANVER includes select models of high efficiency pumps specially designed for ANVER as part of its vacuum lifting systems. These revolutionary regenerative pumps offer a compact, reliable source of quiet, vibration-free vacuum. ANVER's quality pumps are made from tough, high-strength materials for long life, and are lightweight and virtually maintenance free. Their highly efficient, state-of-the-art design has made

older, conventionally designed side-channel blowers obsolete. Pumps are available in capacities of up to 480+ cfm flow and 18 in. Hg vacuum. Powered by high quality TEFC motors, they are more energy efficient, require less horsepower to operate than competitive models, and are offered in several sizes to match your vacuum lifting requirements.

ANVER Vacuum Pumps feature:

- ▶ Direct-drive pumps eliminate the wear-and-tear and alignment problems inherent with belt-drive pumps.
- ▶ Outboard bearings with no metal-to-metal contact, for virtually maintenance-free operation.
- ▶ Oil-free operation simplifies maintenance and eliminates possible sources of contamination.
- ▶ Close-couple design results in a compact, streamlined unit.
- ▶ Mounting is provided for easy installation - No bedframe or concrete foundation is required.

■ High Flow Pumps

For porous loads, ANVER offers High Flow model regenerative pumps. These revolutionary pumps provide a compact and reliable source of quiet, vibration-free vacuum.

■ Ideal for Bags and Boxes

Producing up to 12 in. Hg and 320 scfm of flow, these pumps are an ideal choice for the vacuum lifting of extremely porous bags and boxes.

■ Low Noise Level

Powered by high-quality TEFC motors, their rated operating noise levels are 71 to 76 dB or less. Sound deadening enclosures that further reduce noise levels by 6 dB are also available.

■ Porous Load Lifting

These High Flow Regenerative Pumps are recommended for lifting porous or semi-porous material, such as plywood panels, bags or printed material, and are also used in ANVER VB Vacuum Lifting systems.

■ High Vacuum Pumps

ANVER also offers state-of-the-art design high-efficiency regenerative pumps in our VT vacuum tube lifting systems.

■ Constant Vacuum

Capable of generating a lifting vacuum of 18 in. Hg with a flow capacity of 60 to 125 cfm or more, high-efficiency regenerative pumps are ideal for handling non- or semi-porous loads where

conventional pumps would be inadequate or where high maintenance rotary vane pumps were formerly used.

■ Economically Priced

ANVER's large volume purchasing power allows us to offer any of these high quality pumps as standard with all our VT vacuum tube lifting systems while still maintaining economical system prices.

■ Easy Installation

ANVER Regenerative Vacuum Pumps can be mounted in any position with four mounting bolts. The mounting plate features shock absorption to prevent vibration transmission.

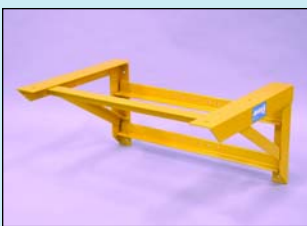

Vacuum Station Bracket



...for almost every application

■ High Efficiency Pumps

ANVER High Efficiency High Vacuum Regenerative Pumps feature a compact design and are ideally suited for vacuum tube lifting of heavy, non-porous and semi-porous loads. They achieve a high vacuum level (18 in. Hg) while being the quietest (71 dB) in the industry.

■ Sound Deadening Enclosures

Optional sound deadening enclosures can reduce operating noise by approximately 6 dB.

■ Energy Efficient

These pumps are far more energy efficient, require less horsepower, and operate at a speed of only 3500-rpm vs. the 7000-rpm common with belt-drive pumps.

■ Ready to Use

All ANVER regenerative pumps are equipped with exhaust mufflers, filters, and vacuum gauges for monitoring the overall system performance, fittings, and hose. Vacuum relief valves to prevent the pumps from operating under a deadhead condition are available as an option.

■ Pumps for Special Applications

For specialized lifting applications, ANVER is able to offer alternate vacuum stations, including systems with pumps designed for use in hazardous duty, explosive environment and wash-down applications.

■ Optional Mounting

Optional stands and wall mounting brackets are available to assist in installing these vacuum pumps away from the work area.

■ Optional Wireless Remote Control

All ANVER tube lift systems can be fitted with a wireless remote control for powering the vacuum pump, useful when the pump is mounted remotely away from the operator's station. The remote control can be attached to the lifter control head or supplied with a belt clip to be worn by the operator.

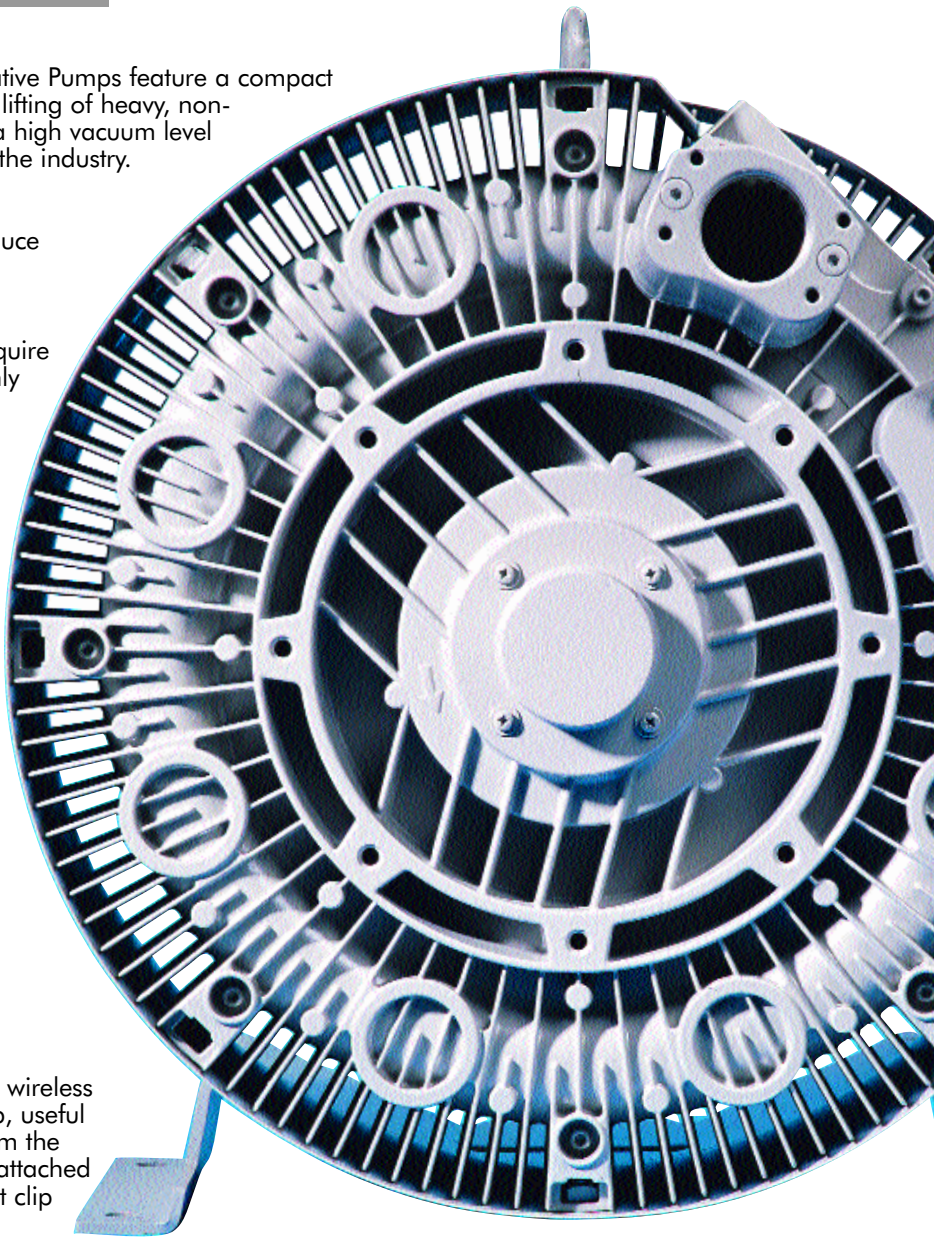

ANVER also offers the latest revolutionarily designed Liquid Ring Water cooled Vacuum Pumps. Once filled, the TCP series requires no external water supply or oil, while maintaining an operating temperature below 110°F (43°C). This ingenious design makes the TCP ideal for continuous duty or hazardous material applications.

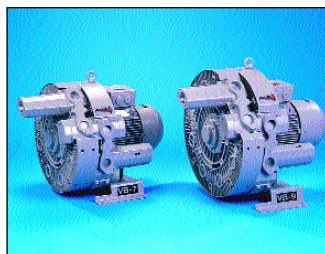

A wide assortment of additional pumps for special applications can also be supplied. Vacuum Pumps with higher vacuum or higher air flow are available, as well as units for use in hazardous duty and explosive environments. ANVER stocks a complete selection, and many loaner pumps are available for same day shipment in emergency cases.



ANVER produces many lines of compressed air powered vacuum pumps, including a line of Multi-Ejector pumps suitable for Tube Lifting Systems. These Air Pumps can be used on the smaller VT tube systems for installations where a dedicated supply of clean, dry, shop air is readily available.



ANVER also stocks a complete inventory of replacement parts and complete belt-drive stations for older systems. Since many older systems were built with these belt drive pumps, ANVER can offer various popular sizes for all competitive systems. You'll find our prices are unbeatable, and we can ship same day from stock.

Vacuum Lift Pad Attachments



■ Standard Vacuum Pad Attachment Included with Each Complete System

Every ANVER VT Tube Lift System price includes a vacuum pad attachment chosen by our applications engineers to suit the job at hand. (No need to consider a pad attachment as an additional add-on cost item.)

Additional pad attachments are readily available and are easily interchangeable to suit your lifting requirements.

■ Fully Adjustable

Multi-pad attachments offer independently adjustable pad slides mounted on an aluminum channel with knurled locking knobs. Pads feature spring and clevis mounts to allow handling of open flaps as well as sealed cartons.

■ Quick Disconnects

Optional Quick Disconnects adjust a full 360°, and can be locked into position, an ANVER Exclusive Feature. ANVER also offers a unique snap-into-position feature that allows pads to rotate 90° and then lock into place.

■ Seals Available in Many Styles

Hundreds of Vacuum Pads made by ANVER's Vacuum Component Group are available. This vast in-house resource allows us great flexibility and quick response when designing and building custom pad attachments.

■ Pad Selection Made Easy

Every ANVER VT Vacuum Tube Lifting System includes a pad attachment specifically chosen by our applications engineers from hundreds of vacuum pad styles and sizes to achieve optimum tube lifting performance. Additional pad attachments are readily available and are easily interchangeable to suit your lifting requirements.

■ Wide Assortment of Pads Available

A wide assortment of vacuum pad attachments makes an ANVER VT System ideal for lifting a variety of loads. The Quick Disconnect option makes changing the pad attachment a snap.

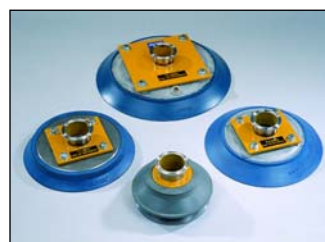

...standard or customized to your needs



■ **Easy Replacement**
ANVER employs a four hole standard bolt mounting arrangement for ease in the upgrading or replacement of vacuum pad attachments.

■ **Special Purpose Pad Attachments**
In addition to our extensive line of rectangular pad attachments, a number of special purpose attachments are available, such as:



■ **Bag Attachment Pads, in Several Different Styles**
for lifting both loosely packed as well as densely packed bags and sacks

■ **Vacuum Pad Seals Securely Attached**
ANVER Vacuum Pad Seals are bolted on or molded in place to prevent seals from peeling off while under the load. Pad attachments have heavy double layer sheet metal construction, and bolt-on vacuum seals are easy to replace in the field. Unlike the competitors' units, there is not an extra charge for this premium construction.

■ **Oval Pads**
for lifting tubes and cylinders

■ **Foam Pads**
for handling rough, uneven or textured surfaces such as stone, concrete or fiberglass and porous signature bundles

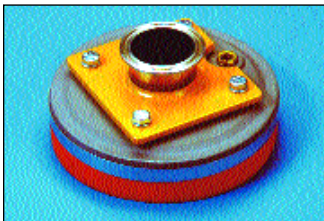
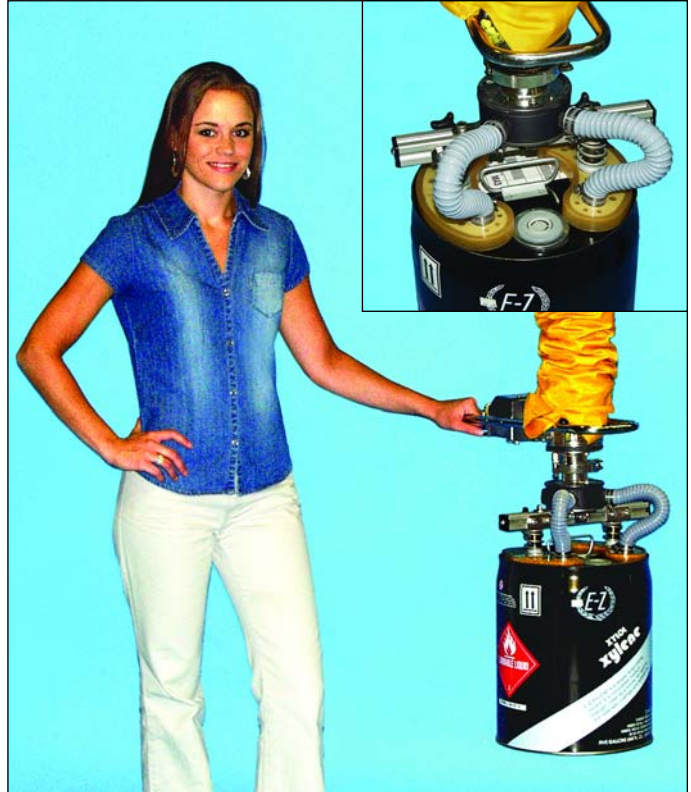

■ **Large Capacity Construction**
All ANVER Vacuum Pad Attachments feature heavy-duty construction, and include grills or screens to prevent the inadvertent ingestion of objects.

■ **Swivel Assemblies**
Swivel assemblies can be attached below the tube lifting head to allow free 360° rotation of the pad attachment independent of the control head, to aid in loading or palletizing. A universal swivel assembly can aid in attaching the pads to an inclined or uneven load and helps ensure that the attached load's weight hangs directly below the lifting tube.

■ **Multi-Pad Attachments**
with pads mounted in-line or H-style, are also available. Multiple pad arrangements are useful for handling more than one object at a time, or for bulky or unusually shaped items.

■ **Extensions**
Pad Attachment Extensions can be used to load and unload deep bins without bending.

■ **Custom Pad Engineering**
ANVER's modular system design, along with our in-house engineering and manufacturing resources, allows us great flexibility and quick response when designing and building custom vacuum pad attachments. Contact ANVER for a free evaluation of your particular product handling requirements.

Vacuum Hose, Filters, Valves,



- ▶ Highest Quality Filters, Hose and Fittings for Maximum Productivity
- ▶ Filters feature a Vacuum Gauge to Monitor System Performance
- ▶ Heavy-duty Drum Filters Available
- ▶ Highest Quality Lift Tube and Hose for Long Life

■ Dual Vacuum Gauges for System Monitoring

Every VT system includes two ANVER Vacuum Gauges, designed for long life and reliable service. One gauge mounted on the control head allows easy monitoring of the system performance by the operator while lifting. A second gauge mounted at the filter housing allows monitoring of the overall system performance.



■ Gauges Help to Reduce Downtime

This tandem arrangement of vacuum gauges aids in quickly locating the source of any degradation in system performance, such as a clogged air filter or a loose hose fitting, helping to keep downtime to a minimum, and improving productivity.

■ Vacuum Filters Extend System Life

All ANVER vacuum systems include in-line vacuum filters to remove contaminants and extend system life.

■ FLT-3 Filters for High Flow Systems

The FLT-3 air filters were specifically designed for use in our high air flow vacuum systems. These lightweight rust-proof plastic filters, with replaceable elements, are well suited for most industrial environments. They are spark/explosion proof, and ideal for food or chemical handling applications.

■ Optional Drum Base

Drum bases with casters are available to aid in drum handling.

■ FLT-4 Long Life Metal Filters

Our FLT-4 metal filter assemblies feature durable steel construction, snap-on fasteners for easy element inspection, a replaceable 10 micron filter element, and factory-inspected seals for 100% airtight operation. Higher efficiency filter elements are also available.

■ Drum Filters for Maximum Filtering

For unusually gritty or dusty environments, 30 and 55 gallon drum filters, (Models FLT-30 and FLT-55), offer maximum filtering performance. The drums are manufactured from heavy-gauge steel to withstand the high vacuum levels typical in an ANVER vacuum lifting system, without the danger of canister implosion possible with thinner-wall standard drums. A 10 micron filter element prevents particulates from being ingested into the pump.

■ Auto-Vent Valves

When releasing non-porous or light loads special automatic vent valves are available to insure a smooth, effortless release.



...Fittings and Miscellaneous Hardware

■ High Flow Vacuum Supply Hose

ANVER vacuum systems include a high-flow crush-resistant plastic supply hose with excellent flexing characteristics and abrasion resistance. Designed for use with blower-type vacuum pumps with large diameter ports, the hose consists of a double-layered high-strength spiral formed PVC hose with a smooth bonded inner surface which minimizes both vacuum drop and loss of flow.

■ Robust Lift Tube for Safer Operation

ANVER Vacuum Lifting Tubes feature a heavy-duty steel-wire reinforced construction. ANVER lifting tubes remain the safest available by reducing the danger of vacuum leakage while at the same time reducing maintenance costs.

■ Quality Components Throughout

The use of PVC hose connector couplings and stainless steel hose clamps complement our use of only the highest quality components to ensure that an ANVER VT Vacuum Tube Lifting System is both of the highest quality, as well as the most economical.

■ Quick Release Disconnects

To improve productivity, optional quick-release disconnects allow the

operator to quickly change pad attachments for varying load handling requirements.

■ Swivel Assemblies

ANVER VT Systems are equipped with a 360° top swivel sealed ball bearing assembly that allows full rotation of the tube lifter. An optional 360° bottom swivel assembly allows full rotation of the control head and attached load for easier load positioning.

■ Vacuum Relief Valves

As most High-Flow (HF) pumps should not be operated in a "deadhead" condition, ANVER VT Systems offer optional adjustable, vibration resistant vacuum relief valves for maximum protection of the pumps.

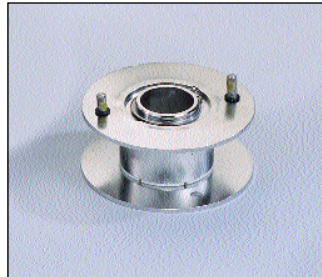
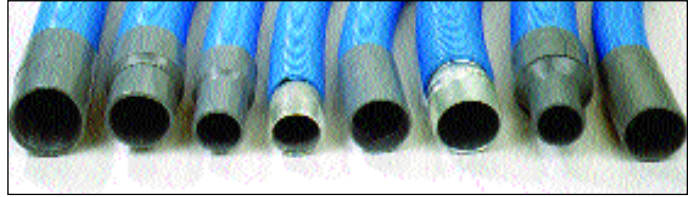

System Controls



Micro Series



Mini Series



Standard Series



Standard Series with Throttle Control

ANVER VT Vacuum Tube Lift System controls have been designed with operator ease, safety and comfort in mind.

■ Simple to Operate

ANVER's vacuum tube lifting system controls are simple to operate, require little operator training, and easily adjust to any operator's optimum working height.

■ Easily Adjustable Load and Height Valve Settings

The operator controls the system vacuum via two vacuum valves with adjusting knobs on the control head. The "no-load" valve sets the horizontal height of the tube lifter when attaching to the load. The "load" valve sets the height to which the load is raised after attachment. Once set, the system continually returns to these height levels for the duration of the operation.

■ Fully Adjustable Valves

Both valves are fully adjustable, allowing the operator to lift and lower any size load within the system's load range. A simple readjustment of these two valves allows new height levels to be set to accommodate a change in load handling requirements.

■ Unconstrained Operation

Operator's hands and fingers remain unconstrained throughout the handling process, with no unnatural motions or straining required to operate the lifter. Repetitive stress injuries, often caused by unnatural twisting of wrists and push-pulling of locked-in fingers, as required to operate the competitors' controls, are eliminated.

■ Ergonomic Controls

The ergonomically designed control handle has made the unit a favorite among operators. The control is activated by simply squeezing the lever with the thumb and fingers in a natural grasping motion.

■ Conical Flow Valve

A redesigned conical flow valve allows the operator to precisely control the vacuum power, resulting in much smoother, more user-friendly control than with competitors' units. This exclusive ANVER design feature allows our VT Tube Lift Systems to more smoothly handle a wider range of load capacities than any competitive brand.

■ Accurate and Consistent Settings

Micro-adjustment and acceleration are accomplished with the same control on the front handle that regulates air suction power. Stainless steel adjustment knobs and nylon fittings on the control head ensure accurate and consistent settings.

■ Food Service Safe

External surfaces combine stainless steel, anodized aluminum and nylon components, all FDA approved for washdown and food service applications. The control head is manufactured using electro-polished heavy gauge corrosion resistant stainless steel.



Extending your reach

■ Vacuum Gauges for System Monitoring

Only ANVER VT Tube Lift Systems are equipped with a vacuum gauge on the control head to readily indicate the system vacuum level to the operator during the lifting operation. This innovative feature helps to make the ANVER VT Tube Lift System the safest to operate in the industry.

■ Compact Mini VT Control

ANVER's Mini VT Tube Lift Systems have a control head similar in design to that of our standard series of tube lift systems, but smaller in size, making them lighter and more compact. The control head is easy to position and its near-effortless movement allows for fingertip control by even the most petite operators.

■ Ultra-Compact Micro VT Control

ANVER's Micro VT Tube Lift System features a compact control designed for one-hand operation and is ideally suited for repetitive lifting and packing of small objects in a confined space.

■ Optional Throttle Grip Control

An optional throttle grip control is available as an alternative to our standard squeeze-lever control. The throttle grip, incorporated in the control handle, allows the operator to regulate the load lifting and lowering by twisting the grip, which is similar to a motorcycle's throttle.

■ Pad and Handle Extensions

Extension handles and pad attachment extensions are available, and easily interchangeable to accommodate different load handling requirements.



■ Gravity Tilters

Optional gravity tilters are available for applications calling for repeatedly tilting the load from vertical to horizontal. An indexing plunger holds the pad in place for vertical attachment to the load.



■ Highest Quality yet Economically Priced

Item for item, ANVER offers the highest quality vacuum tube lifting system. We invite direct comparison to any competitive system. Our VT system's heavy gauge micro-polished stainless steel construction, along with the finest control valves, pumps, pads, hose and filters available, all combined with our economical prices, have rapidly made ANVER the standard in the industry.

■ Quick Pad Disconnects

Extended length handles and swivel controls are available to make high load stacking easier. Quick disconnect pad attachments are available, allowing the operator to quickly change the pad attachment for different load configurations.



VM Vacuum Lifting Systems

► Hoist-based, Fully Integrated Non-Weight Sensitive Systems Ideal for One-Person Handling of Non- to Semi-Porous Loads in Tight Spots

ANVER VM Vacuum Lifting systems are fully integrated systems designed for fast, safe, one person handling of small, compact objects. The VM system can handle the load surfaces of most non- to semi-porous materials and is ideal for repetitive production line use, such as lifting and loading products into a box. A compressed air or electric

vacuum pump provides the suction necessary for load holding; a rugged, electric chain hoist is used for load lifting. The chain hoist provides secure up/down movement, eliminating the possibility of load suspension failure during movement. This allows the load to hang exactly in position when set in place, with no drift.

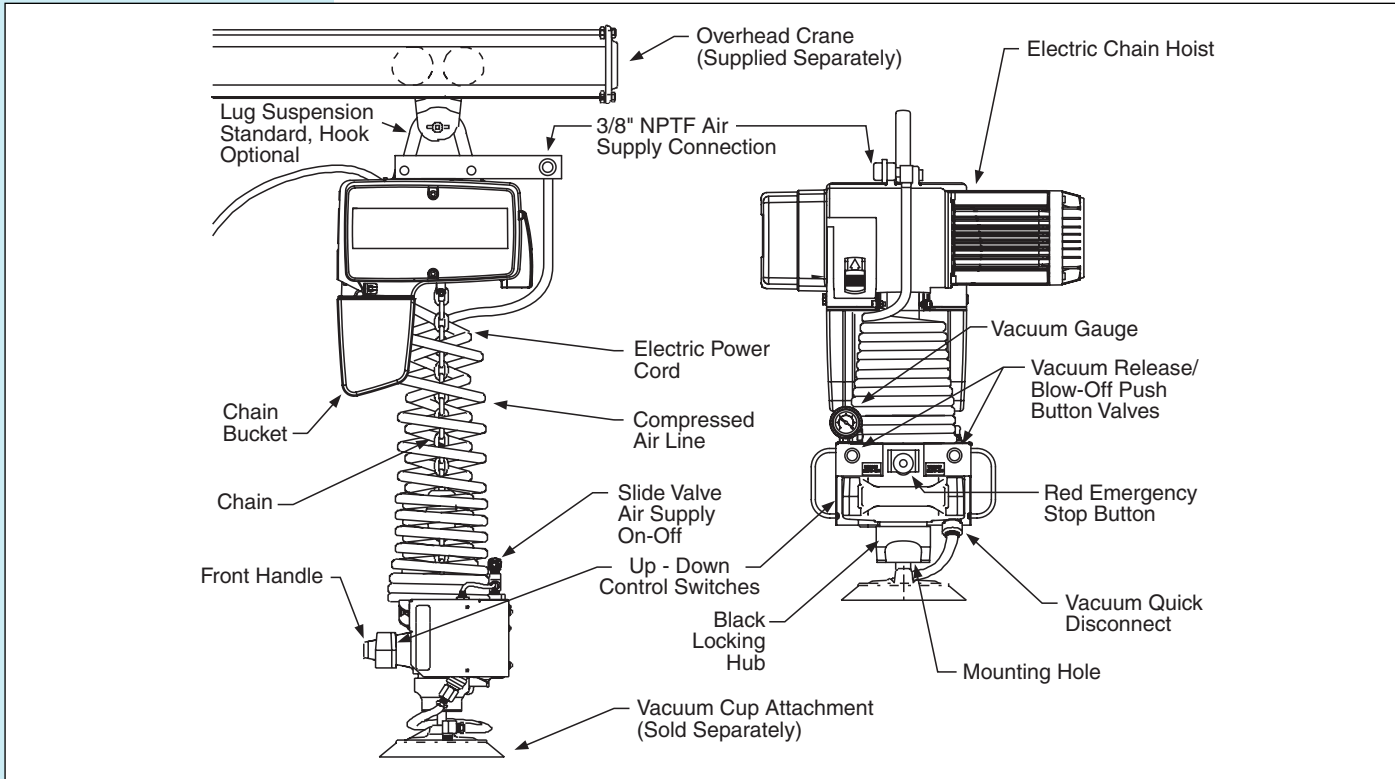

- Low Cost, Low Maintenance, Light Weight, Compact Size
- Secure, Precise Movements Allow Exact Load Positioning
- Can be used as a Hoist and/or a Vacuum Lifter
- Dual Speeds for Maximum Productivity

- **Low Maintenance**
Unlike other vacuum lift systems, there are no large remote pumps, motors and vacuum supply hoses to install and maintain. An ANVER AL101 Compressed Air Venturi or VP1 Electric Vacuum Pump produces the vacuum for attachment.
- **Compact Design**
The VM Vacuum Lift System requires little headroom. The standard lift length varies according to the model selected. Consult factory for headroom and lift length dimensions. Standard system capacities range from 275 to 550 lb (125 to 250 kg.).

- **Easy-to-use, Ergonomic Controls**
Controls are fully integrated and mounted on the control handle. Up and down movement is controlled by dual rocker type switches for right or left thumb control. A separate push button vacuum release valve detaches the load. A vacuum gauge to indicate system vacuum level is mounted on the control to allow for operator monitoring.
- **Continuous Attachment**
Attach is continuous for maximum productivity. As is common with hoist based units, the system is

suitable for one or two lifts per minute. (For higher speed applications, select an ANVER VT Vacuum Tube Lift System).

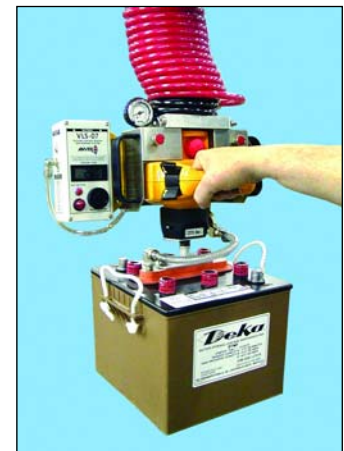

...a fully integrated small vacuum lifter and hoist

■ Dual Speed Chain Hoist

Dual speeds provide maximum productivity in most lifting applications. The integrated chain hook suspension allows precise positioning of the load.

■ Overload and Power Loss Protection

A built-in slip-clutch in the first stage gear prevents hoist overload. A vacuum check valve holds the load in case of power loss.

■ Versatility

The system combines the features of a vacuum lifter with those of a hoist, and can be used for either purpose. The switchover is easy and takes only a few seconds. A built-in slip clutch stops the lift if the system is overloaded.

■ Wide Application

The system is ideal for handling non- to semi-porous objects within arm's reach. A VM system is well suited for repetitive production line tasks such as loading product into boxes. Quick release couplings make it easy to change the lift head for greater versatility.



Specifications

VM Series	275	08	230	09	Generator			
Hoist Capacity	275 = 275 lb	Lowest Speed	230 = 230 volt		Air Consumption	Vacuum Flow	Supply	
	550 = 550 lb	08 = 32 / 8 fpm	460 = 460 volt		SCFM	SCFM	Pressure	
		16 = 64 / 16 fpm	575 = 575 volt		09 = VR09	1.27	0.74	72.5 PSI
		08 = 32 / 8 fpm			20 = JE20H	6.36	4.41	72.5 PSI
		12 = 48 / 12 fpm			25 = JE25H	9.53	7.06	72.5 PSI
					30 = JE30H	14.12	9.36	72.5 PSI

Can be configured so that both vacuum release blow-off push button valves must be depressed together to release load.

* One standard pad attachment is included with each system. Contact factory for special attachments.

**Vacuum capacity for most applications depends on the pad attachment and the vacuum station selected.

...for handling small non- to slightly-porous loads

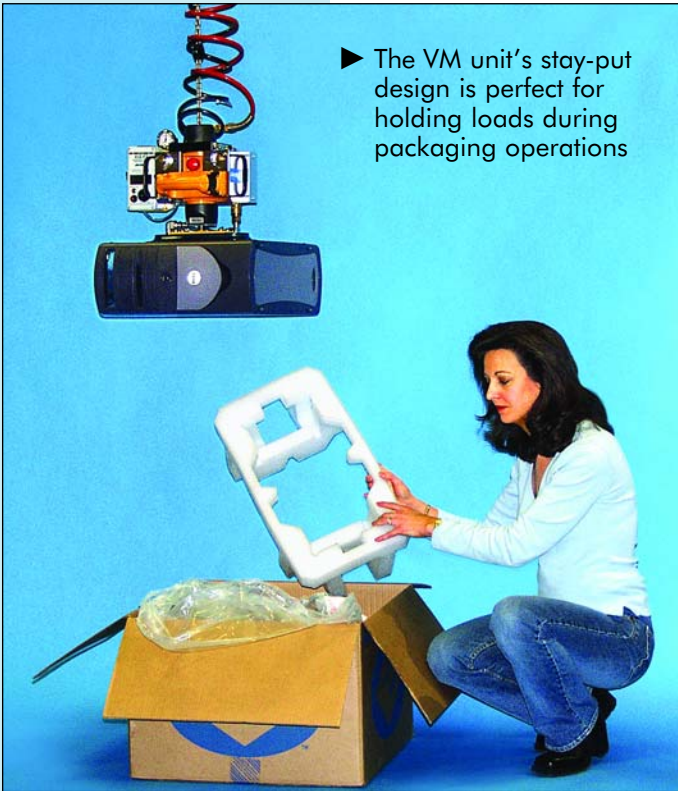

- ▶ The VM unit's stay-put design is perfect for holding loads during packaging operations



- The VM Vacuum-Hoist Lifting System is a compact, easy to use, fully integrated ergonomic lifting system for small load handling.
- The VM Lifter is ideal for loading products into boxes where high air-flow is not required.
- Load attach and release is instantaneous, as the vacuum pump and controls are located at the vacuum attachment head.
- A vacuum pad quick-disconnect feature is standard, and allows for fast pad attachment change-over for greater system load handling versatility.
- The high vacuum level (27" Hg) makes it perfect for attaching to and lifting loads with limited surface attachment areas.

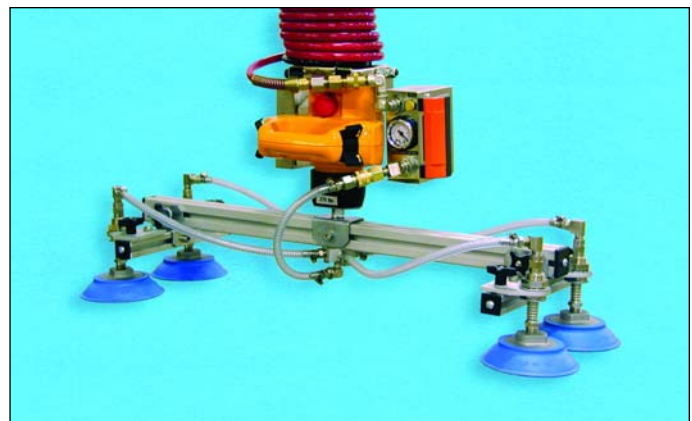
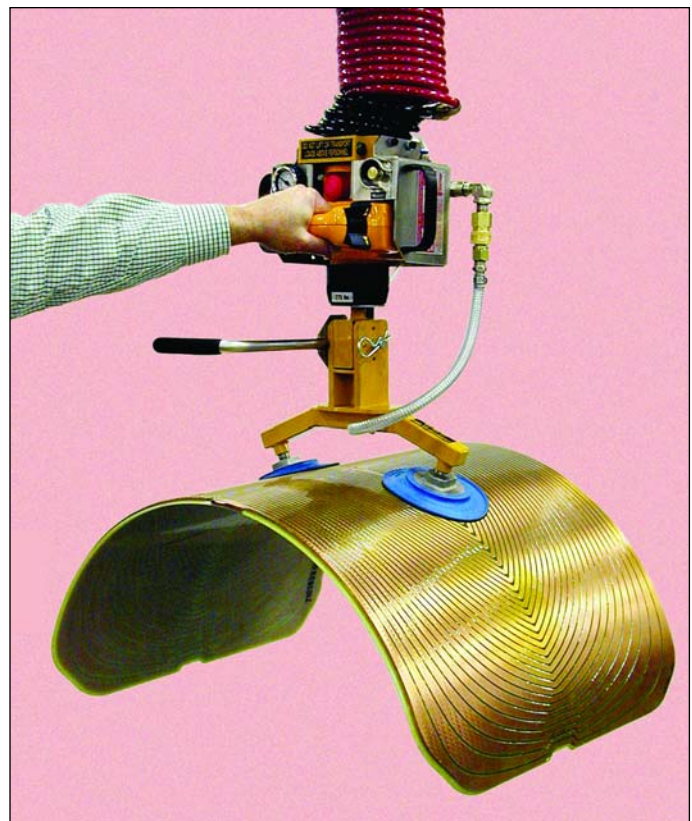

...within arm length, and without any drift or movement



■ The VM Vacuum-Hoist Lifting System is ideal for lifting and handling non-porous or semi-porous heavy, dense loads weighing up to 550 lb (250 kg) that are within arm's reach of the operator.

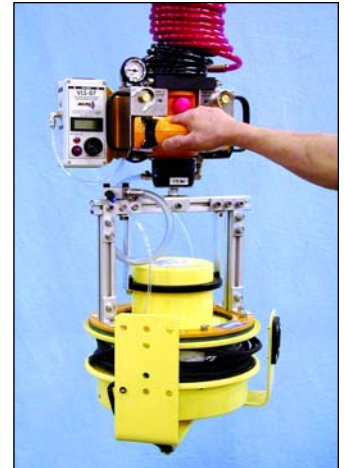
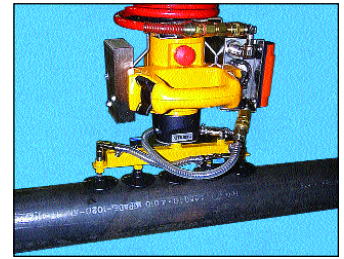

Typical Pad Attachments for VM Vacuum Lifters



■ **Single Vacuum Pad Attachments**
ANVER offers a range of vacuum pad sizes and styles for use with our VM Vacuum-Hoist Lifting systems. Single pad attachments are best suited for lifting small loads such as small packages, pails and drums, small plates and billets, and other compact rigid objects.



■ **Dual Pad Vacuum Attachments**
VM Vacuum-Hoist systems can also be supplied with two pad attachments with the pads either fixed or adjustable on a spreader beam. Dual pad attachments are most suitable for handling mid-sized objects such as microwave ovens, televisions, computer consoles, and windows.



■ **Multi-Pad Vacuum Attachments**
Multi-pad attachments are available with fixed or adjustable crossarms as well as fixed or adjustable pads.

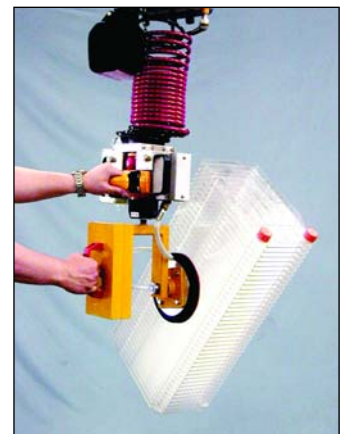

■ **Custom Vacuum Pad Attachments**
Our modular system design and in-house engineering and manufacturing resources allow us great flexibility and quick response when designing and building custom vacuum lifting attachments.

VB Vacuum Lift Systems • Vacuum to hold the load

Heavyweight lifting with a low headroom design.

ANVER VB Vacuum Lifting systems are fully integrated systems designed for fast, safe, one person handling of bags, boxes and other porous-type loads. A large, ultra high

vacuum, direct-drive pump provides the suction necessary for load holding; a rugged, electric chain hoist is used for load lifting.

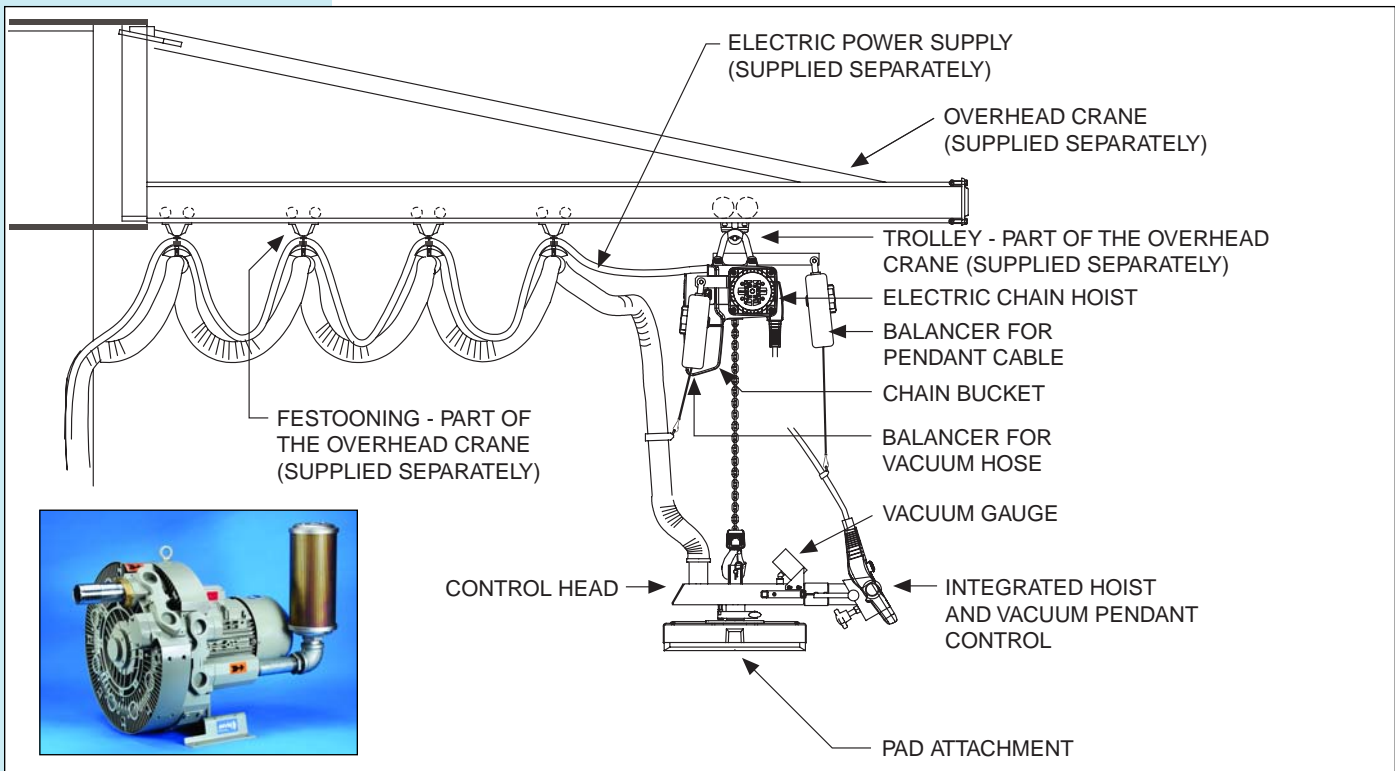

- ▶ Hoist-based, fully integrated, non-weight-sensitive system for handling porous loads in tight spots
- ▶ Precise movements without any vertical drifting
- ▶ Quick, easy, change-over allows use of hoist with hook
- ▶ Superior construction uses only top quality components

■ Precise Lifting

The chain hoist provides secure up/down movement. The load can be set in position to hang exactly where set, with no vertical drift.

■ Compact Headroom

The VB system's compact design requires little headroom. The standard lift length varies depending on which model is selected. Consult factory for headroom and lift length dimensions. Standard load capacities range from 275 to 1,100 lb (125 to 500 kg).

■ Integrated Controls

Easy-to-use, ergonomically designed fully integrated controls are mounted on the handle to operate the vacuum release and hoist movement. A gauge to indicate vacuum level

is mounted on the control to allow for monitoring by the operator. Extended handles with soft rubber grips are available. Handles can be extended for wide or high loads as required.

■ Continuous Vacuum Attachment

Attachment of the load is continuous, for maximum productivity. The hoist is suitable for one or two lifts per minute. (For higher production rates, an ANVER VT Vacuum Tube Lift System should be selected).



... integrated with a chain hoist to do the lifting

■ Dual Speed Chain Hoist

The rugged chain hoist offers secure, precise movement and allows the operator to release or hold the load at an exact height. This feature is very useful for applications such as slowly pouring the contents of a bag into a hopper.

■ Adjustable Vacuum Level

The vacuum level can be reduced temporarily, as might be necessary for separating porous material such as individual sheets of particleboard from a stack.

■ Independent Hoist Operation

VB Systems combine the features of a vacuum lifter with those of a hoist and can be used for either purpose. The switchover is easy and takes only a few seconds. A built-in slip clutch stops the lift if the system is overloaded.

■ Customized Systems

Custom VB units using compressed air powered vacuum hoists with higher duty cycles or units for use in explosive environments are also available. Contact factory for these Systems.



Custom Vacuum Lifting Systems

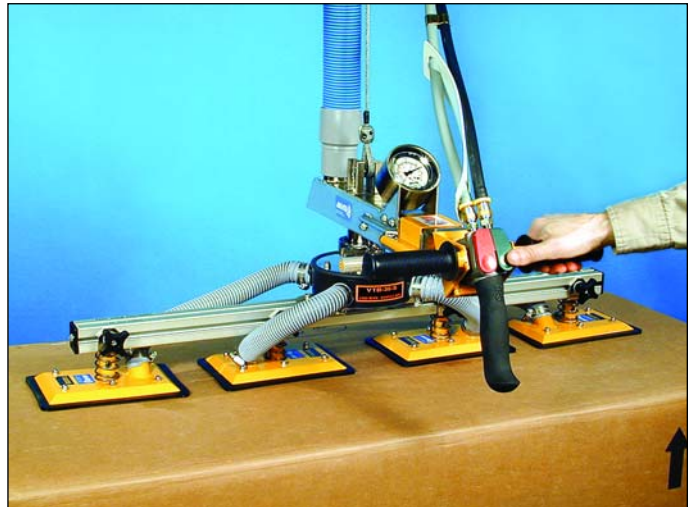

- ▶ Hoist-based, non-weight-sensitive alternatives to tube lift systems for use at low to moderate production rates
- ▶ Superior Construction using only Quality Components
- ▶ Quick Disconnects are standard; changing the lift pad is a snap
- ▶ Integrated Controls for Easy Operation
- ▶ Requires very little headroom
- ▶ High Quality, yet Value-Priced
- ▶ Hoist-based systems for approximately two lifts per minute. Please consult factory for detailed specifications.

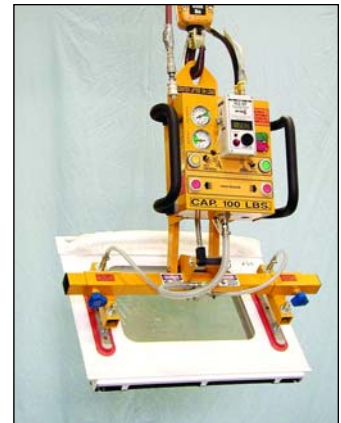

■ Wide Range of Lifting Capability

VB and VM systems use vacuum to secure and hold the load only, not for lifting; the hoist provides the lift.

■ Compact, Easy to Control

These compact systems are quick and easy to control by a single operator. A rugged chain hoist is used for secure and precise up-and-down movement. The integrated hoist features a built-in automatic overload sensor to stop the lift if the system is overloaded. A slip-clutch in the first stage hoist gear prevents hoist overload.

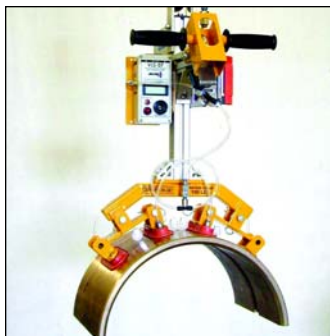

...for almost any load



ANVER vacuum systems are also available for use with balancers, for special handling of non- to semi-porous loads in place of chain hoists.

- Components, and attachments or complete systems for Air Balancers are available.
- ANVER Air Balancer Systems can include safety features such as fail-safe load release circuitry, non-release prior to unloading, dual button release, etc.

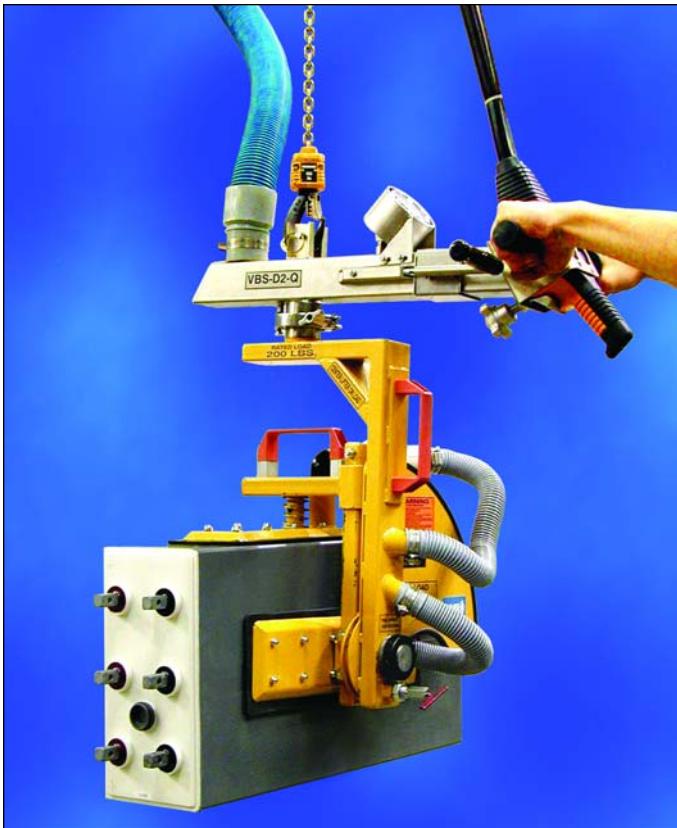

- Hoist-based systems are most useful at low to moderate production rates. When high production rate lifting is required, a continuous duty cycle tube lift system should be used.
- ANVER also offers systems using oil-free air hoists and balancers for special applications. Contact factory for details.

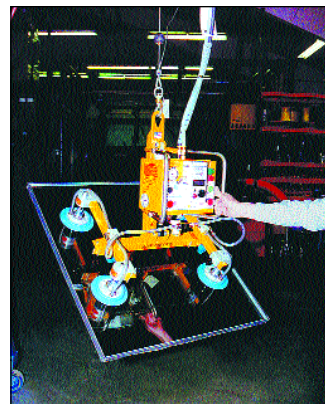

- Rated load capacities for standard models range up to 1,100 pounds (500 kg). Hoists with higher rated load capacities are available if the user wishes to have the capability of operating the hoist alone for lifting heavier loads, independent of the vacuum attachment system.

- Contact ANVER for assistance in determining the suitability of an Air Balancer system for your particular application.

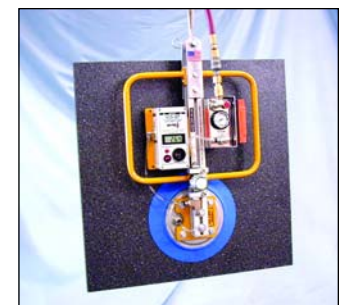
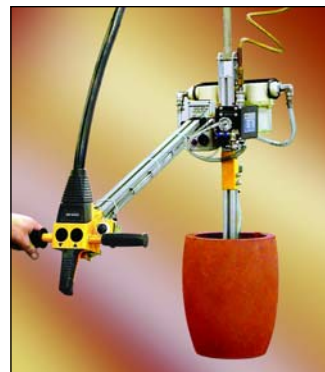
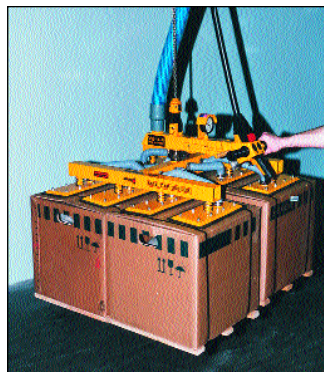



Order Complete Systems, Sub-Assemblies or just the parts you need.



Visit us at: WWW.ANVER.COM



Quick Ship Spare Parts

Largest Stock Available • Made in USA since 1968

Complete System
Clickable Link Index
on WWW.ANVER.COM

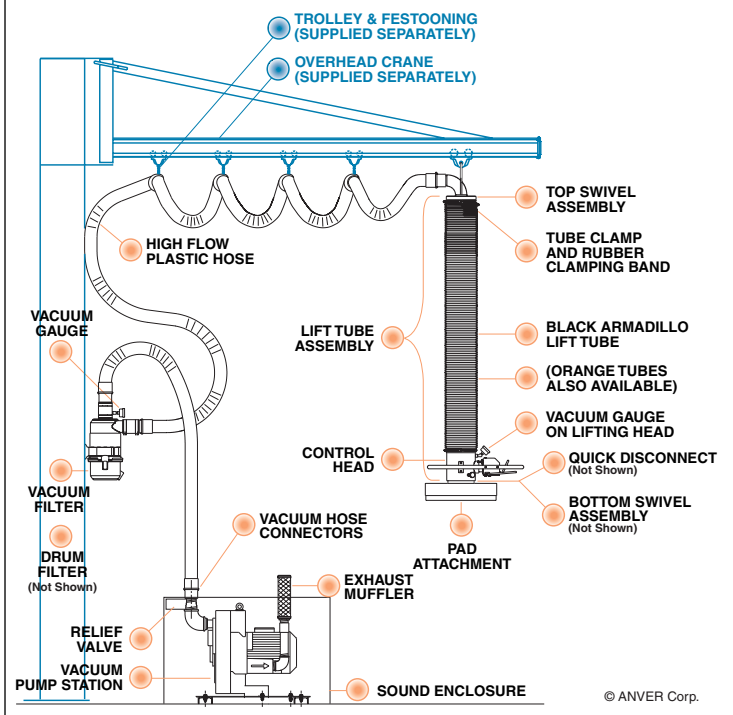

Distributed in your area by:

Free Literature + Expert Advice

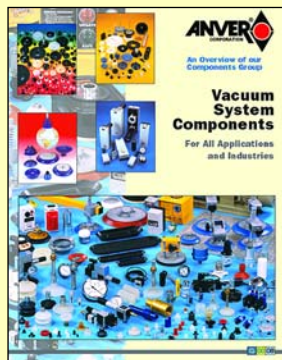

Contact us for Free Literature on any of our Product Groups:

- Vacuum Components
- Vacuum Lifters
- Ergonomic Lifting Systems
- Hand Vacuum Cups
- Vacuum System Automation
- Bottling End Effectors

36 Parmenter Road, Hudson, MA 01749 USA
 Tel: 800-654-3500 • 978-568-0221 • Fax: 978-568-1570
 e-mail: sales@anver.com • website: www.anver.com

Self-Powered, Self-Cycling Units Create Their Own Grip Mechanically



ANVER Mechanical Vacuum Lifters do not rely on plant power, outside controls, or complex accessories. These self-contained units create their own vacuum mechanically, giving them unmatched versatility for use in metal fabricating plants, service centers, warehouses, and plate yards. These lifters offer instant attach and release via the hoist up and down. The internal piston and non-wearing rolling diaphragm create vacuum and will work silently with minimum maintenance for years.

One person simply attaches the hook of the crane, hoist, or boom truck to the lifter, positions the lifter on the load and controls the entire operation alone. The attach and release

alternates each lift cycle for fast, efficient handling.

Mechanical lifters increase speed and efficiency of horizontal handling of sheet and plate, fabrications, panels, and all types of nonporous materials.



How ANVER® Mechanical Vacuum Lifters Work

Up/Down Movement of Hoist Controls Vacuum Attach and Release
Simple On/Off Cycle is Quick and Reliable

Basic Operating Procedure

1. The lifter is hanging from the crane hook and is lowered onto the load until the chain is slack.
2. The lifter is pulled up by the hoist and picks up the load.
3. The lifter and the load are set down until the chain is completely slack.
4. The lifter can now be raised without the load.
5. Set the lifter down again until the chain is completely slack and is ready to pick up the next load.

Technical Description

The vacuum generator of these lifters consists of a free-moving piston within a closed cylinder. A rubber rolling diaphragm forms an airtight seal between piston and cylinder. Since the integrity of this seal does not depend on metal-to-metal contact or a tight fit, it does not lose efficiency with use.

The vacuum attach and release cycle is controlled by an automatic self-cycling valve located in the bottom of the piston. When the unit is lowered onto the load and the suspension valve slackens, a cam automatically closes the piston valve. The hoisting action then pulls up the piston, creating a powerful vacuum inside the cylinder and underneath the vacuum pads. When the load is completely set down, and the suspension chain is again slackened, the cam opens the piston valve, releasing the vacuum. The lifter then can be raised, ready for the next pickup. Attach and release are instantaneous. Since the valve sealing disc can only cycle when the chain is completely slack, it cannot shift positions while in use and accidentally release the load.

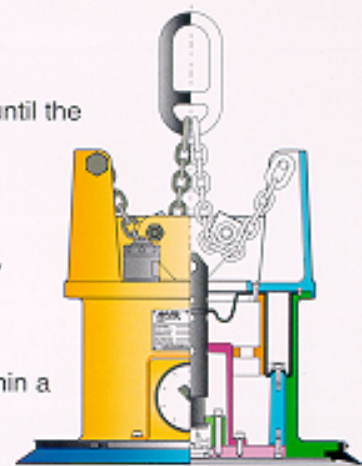

Unique Features Set the Standard in Vacuum Lifters for Sheet and Plate Handling

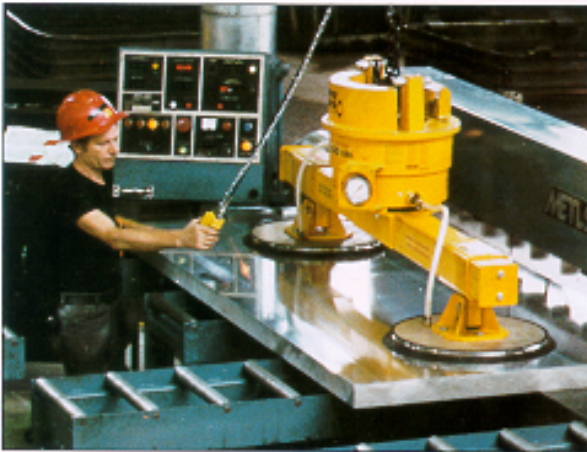

Vacuum Lifters with Mechanical Generators Offer Unique Advantages

- No installation required. Simply attach the hook of a hoist, crane, or boom truck to the lifter and it's ready for operation!
- Attach and release are controlled by the up and down movement of the hoist. The vacuum control valve alternates between attach and release each time the lifter is picked up or set down.
- An operator cannot release a load without setting down the lifter load and until the chain is slack.
- No control buttons of any kind on the lifter.
- No external power source or festooning required.
- Unit can be spun around 360° without limitation, as there are no electric or air lines to tangle.
- Not affected by power failures or power brownouts. Safe around water burning tables.
- Totally silent operation creates no oil mist or pollution. Extremely efficient, low-cost operation.
- Lowest maintenance requirements of all vacuum lifters. Rebuilds are infrequent and simple.
- Suitable for 100% duty cycle, 24 hours a day operation. They never overheat or burn-out.

Adjustable for Varying Load Sizes

- Cups are adjustable on crossarms.
- Crossarms are adjustable on the beam.
- Crossarms can pivot to near parallel.
- Outside cups can be shut off with ball valves.

Leaves no Trace on the Load

- Cups are non-marking, non-marring.
- Bottom springs for even attachment.
- Top springs for even loading when lifting.
- Ball-in-socket articulated suspensions for wavy or blocked plate.

Simple to Set Up and Use

- Shipped fully assembled and vacuum tight.
- No installation required, just attach and go!
- Front and end-of-beam handlebars standard.
- Minimal training of operator, no buttons to use.

Premium Construction for Long Life

- Built utilizing the latest CAD/ CAM techniques and advanced materials.
- Top quality fit-and-finish: Epoxy paint, Nickel-plated Hardware throughout. Built rugged with heavy welded steel construction.

Easy to Maintain and Keep Operating in Heavy Production Environments

- New SSR Snap-In Sealing Rings for cup replacement in seconds without tools.
- No wires or hose to tangle up in the hoist chain; no fuses, motors or switches.
- Mechanical Vacuum Lifters cannot overheat and are not affected by brownouts.

ANVER Lifters comply fully to US ANSI and OSHA and European CE mark requirements.

STARQUIP industrial products Ltd.

40 Dynamic Drive, Unit 4, Toronto, ON ☎ M1V 2W2 ☎ Tel: (416) 286-7116 Fax: (416) 286-8595
e-mail info @starquip.com
web www.starquip.com

ANVER VACUUM TUBE LIFTING SYSTEMS



Simple to Operate

ANVER vacuum tube lifting system controls are simple to operate, require little operator training, and easily adjust to any operator's optimum working height.

Easily Adjustable Load and Height Settings

The operator controls the system vacuum via two vacuum valves with adjusting knobs on the control head. The "no-load" valve sets the horizontal height of the tube lifter for attaching to the load. The "load" valve sets the height to which the load is raised after attachment. Once set, the system continually returns to these height levels for the duration of the operation.

STARQUIP industrial products Ltd.

40 Dynamic Drive, Unit 4, Toronto, ON ☎ M1V 2W2 ☎ Tel: (416) 286-7116 Fax: (416) 286-8595
e-mail info @starquip.com
web www.starquip.com

ANVER VACUUM TUBE LIFTING SYSTEMS



Simple to Operate

ANVER vacuum tube lifting system controls are simple to operate, require little operator training, and easily adjust to any operator's optimum working height.

Easily Adjustable Load and Height Settings

The operator controls the system vacuum via two vacuum valves with adjusting knobs on the control head. The "no-load" valve sets the horizontal height of the tube lifter for attaching to the load. The "load" valve sets the height to which the load is raised after attachment. Once set, the system continually returns to these height levels for the duration of the operation.

STARQUIP industrial products Ltd.

40 Dynamic Drive, Unit 4, Toronto, ON M1V 2W2 Tel: (416) 286-7116 Fax: (416) 286-8595
e-mail info@starquip.com
web www.starquip.com

ANVER VACUUM TUBE LIFTING SYSTEMS

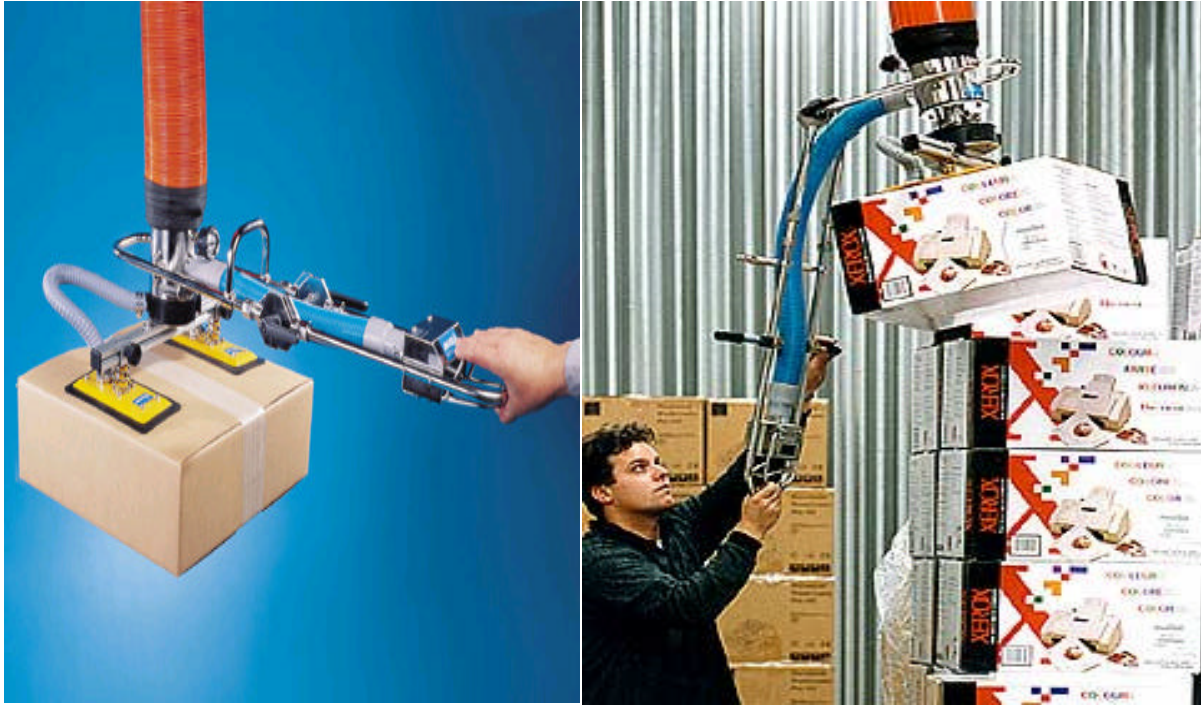

Simple to Operate

ANVER vacuum tube lifting system controls are simple to operate, require little operator training, and easily adjust to any operator's optimum working height.

Easily Adjustable Load and Height Settings

The operator controls the system vacuum via two vacuum valves with adjusting knobs on the control head. The "no-load" valve sets the horizontal height of the tube lifter for attaching to the load. The "load" valve sets the height to which the load is raised after attachment. Once set, the system continually returns to these height levels for the duration of the operation.

Fully Adjustable Valves

Both control valves are fully adjustable, allowing the operator to lift and lower any size load within the system's load range. A simple readjustment of these two valves allows new height levels to be set to accommodate a change in load handling requirements.

Unrestrained Operation

Operator's hands and fingers remain unrestrained throughout the handling process, with no unnatural motions or straining required to operate the lifter. Repetitive stress injuries, often caused by unnatural twisting of wrists and push-pulling of locked-in fingers, required to operate competitive controls, are eliminated.

Ergonomic Controls

An ergonomically designed control handle has made the unit a favorite among operators. The control is activated by simply squeezing the lever with the thumb and fingers in a natural grasping motion.

Conical Flow Valve

A redesigned conical flow valve allows the operator to precisely control the vacuum power, resulting in a much smoother, more user-friendly control than competitive units. This exclusive ANVER design feature allows our VT tube lift systems to more smoothly handle a wider range of load capacities than any competitive brand.

Safety Check Valve

A Power Loss Safety Check Valve built into the 360-degree top swivel slowly lowers the load if power supply to the vacuum pump is interrupted.

Accurate and Consistent Settings

Micro-adjustment and acceleration are accomplished with the same control on the front handle that regulates air suction power. Stainless steel adjustment knobs and nylon fittings on the control head ensure accurate and consistent settings.

Food Service Safe

External surfaces combine stainless steel, anodized aluminum and nylon components, all FDA approved for washdown and food service applications. The control head is manufactured using electro-polished heavy gauge stainless steel for corrosion resistance.

Vacuum Gauges for System Monitoring

Only ANVER VT Tube Lift Systems are equipped with a vacuum gauge on the control head to readily indicate to the operator the system vacuum level during the lifting operation. This innovative feature helps to make an ANVER VT Tube Lift System the safest to operate in the industry.

Quick Pad Disconnects

Extended length handles and swivel controls are available to make high load stacking easier. Quick disconnect pad attachments are available, allowing the operator to quickly change the pad attachment for differing load configurations.

Highest Quality yet Economically Priced

Item for item, ANVER offers the highest quality vacuum tube lifting system, which is the key to our continuing success. We invite direct comparison to any competitive system. Our VT system's heavy gauge micro-polished stainless steel construction, along with the finest control valves, pumps, pads, hose and filters available, all combined with our economical prices, have rapidly made ANVER the standard in the industry.

FOR MORE INFORMATION ON THE ANVER TUBE LIFTERS PLEASE CONTACT:

Starquip Integrated Systems
40 Dynamic Drive, #4
Toronto, Ontario
M1V 2W2

Tel: 416-286-7116
Fax: 416-286-8595

info@starquip.com
www.starquip.com

FOR MORE INFORMATION ON THE ANVER TUBE LIFTERS
PLEASE CONTACT:

Starquip Integrated Systems
40 Dynamic Drive, #4
Toronto, Ontario
M1V 2W2

Tel: 416-286-7116
Fax: 416-286-8595

info@starquip.com

www.starquip.com